



Laboratory Compound Optical Microscope 1000x

Our Product Introduction

for more products please visit us on cnoec.com

Basic Information

- Place of Origin: China
- Brand Name: CNOEC, OPTO-EDU
- Certification: CE, Rohs
- Model Number: A12.2603
- Minimum Order Quantity: 1 pc
- Price: FOB \$1~1000, Depend on Order Quantity
- Packaging Details: Carton Packing, For Export Transportation
- Delivery Time: 5~20 Days
- Payment Terms: T/T, West Union, Paypal
- Supply Ability: 5000 pcs/ Month



Product Specification

- Eyepiece: WF10x/20
- Nosepiece: 5 Holes
- Objective: Infinity Plan 4x10x40x100x
- Working Stage: Double Layer Mechanical
- Condenser: Abbe N.A.1.25
- Focusing: Coaxial Coarse & Fine
- Light Source: LED
- Power Supply: 100~240V
- Magnification: 40x,100x,200x,400x,1000x
- Highlight: **binocular compound microscope, wide field microscope**



More Images

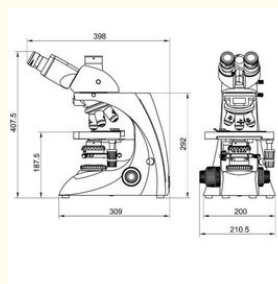
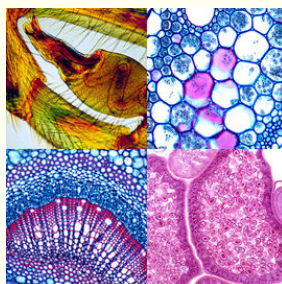
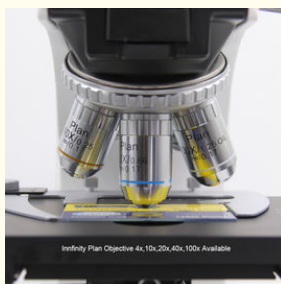

Product Description

OPTO-EDU A12.2603 Biological Research Use Trinocular Lab Microscope With Factory Price

A12.2603 is a type of laboratory biological microscope, it is designed for college teaching and hospital. It is the original style which can upgrade to other microscopes, like polarizing microscope and fluorescent microscope. The features of steady structure, convenient operation and clear image is suitable for observing various biological specimens, and mostly applied in college and hospital.



OPTO-EDU (BEIJING) CO., LTD.

F-1501 Wanda Plaza, No.18 Shijingshan Road, Beijing 100043, China
Tel:+8610 88696020 Fax:+8610 88696085

A12.2603

Laboratory Biological Microscope



A12.2603 Upgraded From A12.2602



- (1) Head Upgrade To Large Size With Eyepiece Tube Dia.30mm
- (2) Eyepiece Upgrade To Dia.30mm Diopter Adjustable
- (3) Standard Objectives Upgrade To 5 pcs With 20x
- (4) Working Stage Upgrade To Large Size Rackless 182x140mm
- (5) Condenser Upgrade To Swing Out Condenser N.A.0.9/0.13
- (6) Light Source Upgrade to 6V30W High Brightness + Blue Filter

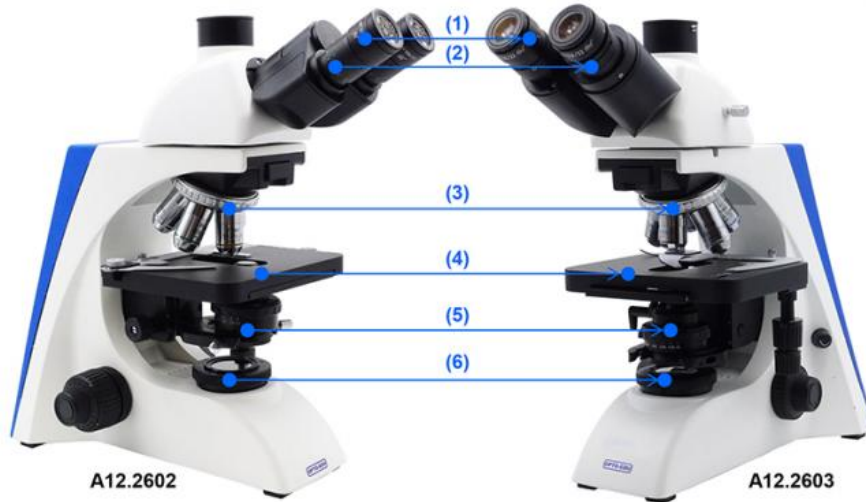

Super Wide Field SWF10x/22mm
Eyepiece Dia.30mm Diopter Adjustable

Super Wide Field Eyepiece

SWF10x/22mm, Eyepiece Dia.30mm Diopter Adjustable



Eyepiece Tube With Fix Screw And Eyepiece Dia.30mm

The Eyepiece Tube Has Fix Screw

To Prevent Eyepiece Falling Damage During Move



Fixed E80:P20 (Optional)



E100:P0/E0:P100

Trinocular Head Light Split Optional Between Switch E100:P0/E0:P100 And Fixed E80:P20

In Fixed Light Split, Eyepiece 80% : Photo 20% User Can View Image At Same Time In Both Path
In Switch Light Split, Eyepiece 100%:Photo 0% / Eyepiece 0%:Photo 100%, Camera Can Have 100% Light For Photo Capture.



Infinity Plan Objective 4x,10x,20x,40x,100x Available

Abbe Condenser N.A.1.25

Large Size High Precision Quintuple Nosepiece, With Polarizing Analyzer Slot, Infinity Plan Objective 4x,10x,20x,40x,100x Available
Creative 100X Water Objective (Optional) Instead Of 100X Oil Objective, More Convenient For Using & Cleaning After Use



Rackless (Integrated) Mechanical Stage,
Large Size 182×140mm, Double Slide Holder

Rackless (Integrated) Mechanical Stage

Large Size 182×140mm, Double Slide Holder, Travel Range 77×52mm



Swing-out Condenser,N.A.0.9/0.13,Iris Diaphragm

Swing-out Condenser,N.A.0.9/0.13,Iris Diaphragm

Control The Amount Of Light According To Demand, The Effect Is More Perfect.



Powered By Safety Low Voltage Charger, Input Wide Voltage 100V-240V, Output 5V1A, Support Power Bank Supply For Outdoor Use

Product Accessories



A51.2602-1020
WF10X/20mm
(High Eyepoint)



A56.2610-BK
Dark Field
Condenser, Dry



A56.2610-BKW
Dark Field
Condenser, Immersion



A56.2660
ECO, Auto
Power Off System



A52.2606 Infinity Plan Objective



A55.2610
Digital Eyepiece
Camera Adapter



A5P.2601-BK Analyzer + Polarizer Set



A55.2601-10
C-Mount 1.0x,
Focus Adjustable



A5C.2602
Simple Phase
Contrast
Attachment



A55.2601-75
C-Mount 0.75x,
Focus Adjustable



**A5C.2603 Turret
Phase Contrast Attachment**



A55.2601-05
C-Mount 0.5x,
Focus Adjustable

Items	A12.2603 Laboratory Biological Microscope Specification	-B	-T	Cata. No.
A12.2603 Upgrade From A12.2602	--Head Upgrade To Large Size With Eyepiece Tube Dia.30mm --Eyepiece Upgrade To Dia.30mm Diopter Adjustable --Standard Objectives Upgrade To 5 pcs With 20x --Working Stage Upgrade To Large Size Rackless 182x140mm --Condenser Abbe N.A.1.25 Upgrade To Swing Out Condenser N.A.0.9/0.13 --Light Source Upgrade to 6V30W High Brightness + Blue Filter			
Head	Seidentopf Binocular Head Inclined 30°,Rotatable 360°, Interpupillary Distance 48-76mm, Eyepiece Tube Dia.30mm	●	○	A53.2623-B
	Seidentopf Trinocular Head Inclined 30°,Rotatable 360°, Interpupillary Distance 48-76mm, Light Split Switch E100:P0/E20:P80, Eyepiece Tube Dia.30mm	○	●	A53.2623-T
Eyepiece	WF10x/22mm, Dia.30mm , High Eyepoint, Diopter Adjustable	●●	●●	A51.2621-1022

Nosepiece	Quintuple	●	●	A54.2610-N01
Infinity Plan Objective	PLAN 2.5X/0.07,W.D.=8.47mm	○	○	A52.2606-2.5
	PLAN 4X/0.10,W.D.=12.10mm	●	●	A52.2606-4
	PLAN 10X/0.25,W.D.=4.64mm	●	●	A52.2606-10
	PLAN 20X/0.40(S),W.D.=2.41mm	●	●	A52.2606-20
	PLAN 40X/0.66(S),W.D.=0.65mm	●	●	A52.2606-40
	PLAN 60X/0.80(S),W.D.=0.33mm	○	○	A52.2606-60
	PLAN 100X/1.25(S,Oil),W.D.=0.12mm	●	●	A52.2606-100
	PLAN 100X/1.15(S,Water),W.D.=0.19mm	○	○	A52.2606-100W
Working Stage	Rackless (Integrated) Mechanical Stage, Size 182×140mm, Travel Range 77×52mm, Double Slide Holder	●	●	A54.2601-S10
	Mechanical Stage Size 175 mm×145mm, Travel 76mmX52mm, Scale: 0.1mm, Double Slide Holder	○	○	A54.2601-S01
Focusing	Coaxial Coarse & Fine Focusing, Coarse Focusing Travel Range: 22mm, Fine Focusing Div. 0.002mm	●	●	
Condenser	Swing-out Condenser,N.A.0.9/0.13,Iris Diaphragm	●	●	A56.2614-07a
Illumination	6V30W Halogen Koehler Illumination, With Field Diaphragm Power Supply Wide Voltage 100V~240V	●	●	A56.2613-6V30W
	3W LED Koehler Illumination, Field Diaphragm Powered By Safety Low Voltage Charger, Input Wide Voltage 100V-240V, Output 5V1A, Support Power Bank Supply For Outdoor Use	○	○	A56.2651-3W
Field Diaphragm	For Kohler Illumnation	●	●	A56.2615-BK
Power	ECO, Auto Power Off System. Power Off Automatically Upon User Leaving 10 Minutes, Power On Automatically Upon User Approaching Detected, This Function Can Be Shut Down Manually	○	○	A56.2660
Filter	Dia.45mm, Blue	●	●	A56.2616-45B
	Dia.45mm, Green	○	○	A56.2616-45G
	Dia.45mm, Yellow	○	○	A56.2616-45A
Dark Field	Dark Field Condenser, Dry, N.A.0.83-0.91, For 4x10x40x Objective	○	○	A5D.2610-BK
	Dark Field Condenser, Immersion, N.A.1.3, For 100x Objective			A5D.2610-BKW
Polarizing	Analyzer + Polarizer Set	○	○	A5P.2601-BK
Phase Contrast	Infinity Plan Phase Contrast Objective 10x + Phase Contrast Slide 10x + Phase Contrast Condenser + Telescope 11x + Green Filter	○	○	A5C.2602-10
	Infinity Plan Phase Contrast Objective 20x + Phase Contrast Slide 20x + Phase Contrast Condenser + Telescope 11x + Green Filter	○	○	A5C.2602-20
	Infinity Plan Phase Contrast Objective 40x + Phase Contrast Slide 40x + Phase Contrast Condenser + Telescope 11x + Green Filter	○	○	A5C.2602-40
	Infinity Plan Phase Contrast Objective 100x + Phase Contrast Slide 100x + Phase Contrast Condenser + Telescope 11x + Green Filter	○	○	A5C.2602-100
	Turret Phase Contrast Attachment Infinity Plan Phase Contrast Objective 10x20x40x100x, Turret Phase Contrast Condenser 5-Holes, Telescope 11x, Green Filter	○	○	A5C.2603-BK
Fluorescence	Upgrade to A16.2604-T2 Fluorescence Microscope With A5F.2601-2: B,G China Fluorescent Set 100W Mercury Lamp House 100W Mercury Power Box, Digital Disp. 6 Holes Disc Fluorescent Unit Ultraviolet Protection Barrier Centering Objective China 100W Mercury Lamp 2 pcs		○	A5F.2601-2
	Upgrade to A16.2604-T4 Fluorescence Microscope With A5F.2601-4: B,G,U,UV China Fluorescent Set 100W Mercury Lamp House 100W Mercury Power Box, Digital Disp. 6 Holes Disc Fluorescent Unit Ultraviolet Protection Barrier Centering Objective China 100W Mercury Lamp 2 pcs		○	A5F.2601-4
	Upgrade to A16.2604-LT2 Fluorescence Microscope With A5F.2602-2: B,G China Fluorescent Set 6 Holes Disc Fluorescent Unit 5W LED Lamp House 5W LED Power Box Ultraviolet Protection Barrier		○	A5F.2602-2
	Upgrade to A16.2604-LT4 Fluorescence Microscope With A5F.2602-4: B,G,U,UV China Fluorescent Set 6 Holes Disc Fluorescent Unit 5W LED Lamp House 5W LED Power Box Ultraviolet Protection Barrier		○	A5F.2602-4
Adapter	C-Mount 0.5x, Focus Adjustable	○	○	A55.2601-05
	C-Mount 0.75x, Focus Adjustable	○	○	A55.2601-75
	C-Mount 1.0x, Focus Adjustable	○	○	A55.2601-10
	Digital Eyepiece Camera Adapter, Dia. 23.2mm/25mm	○	○	A55.2610

Package	Carton Size 520×475×285mm, 1 Unit/Ctn
Weight	Gross Weight: 12 kgs, Net Weight: 10 kgs
Note: "●" In Table Is Standard outfits, "○" Is Optional Accessories	

Product Multi-angle



General Layout Diagram

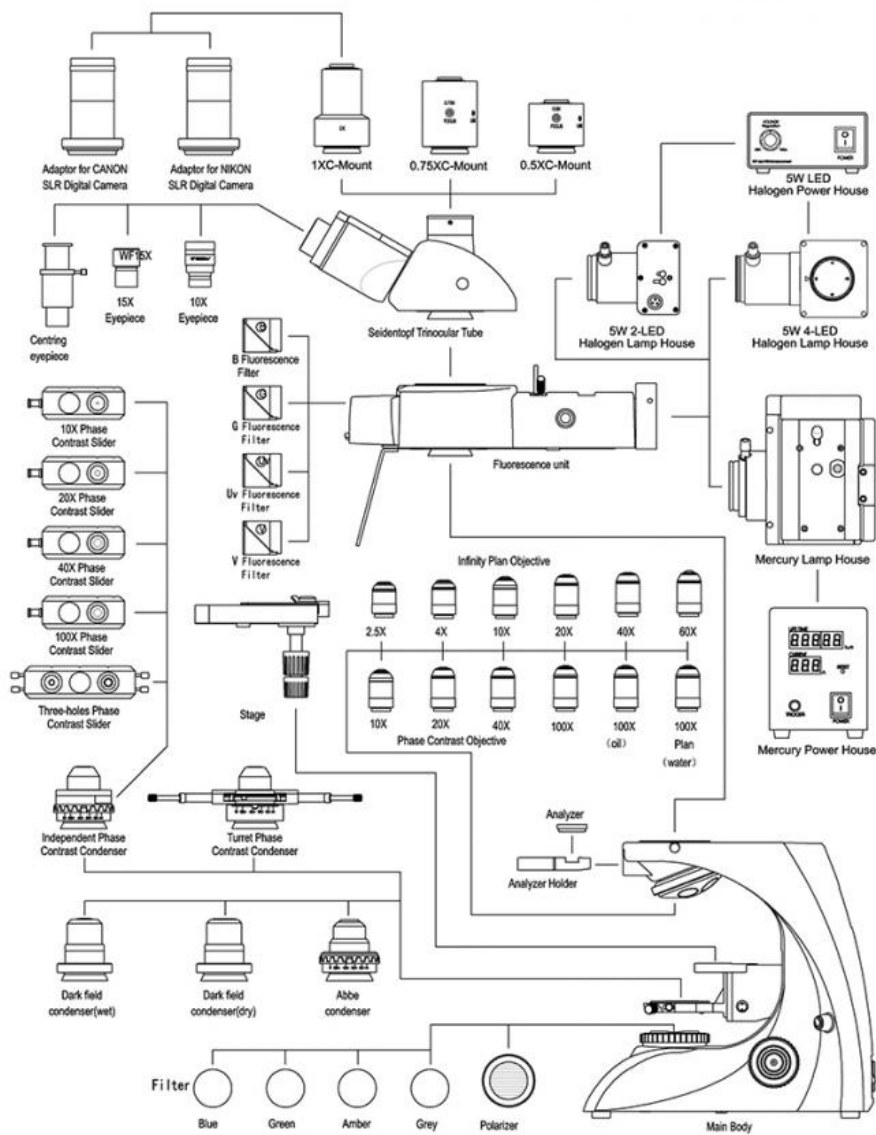

Product Size(mm)

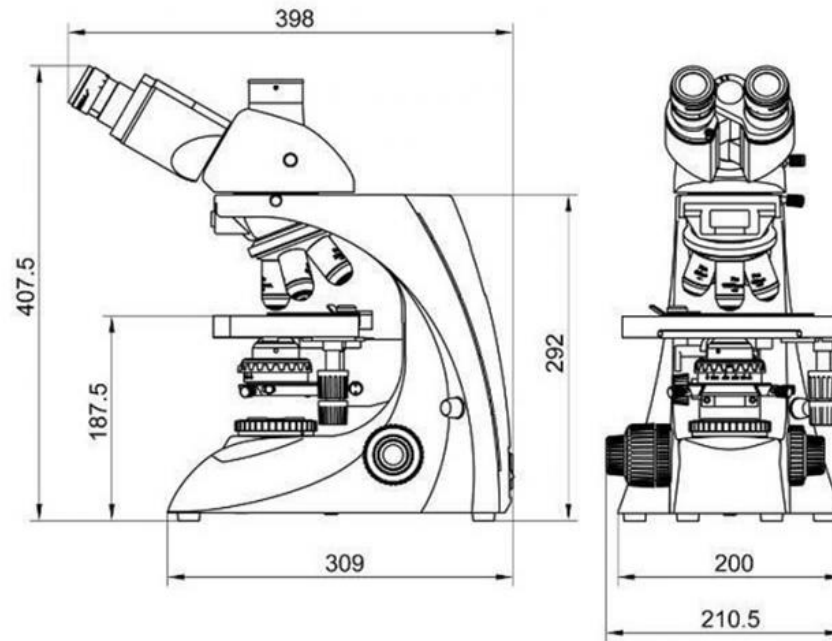

Product Upgrade

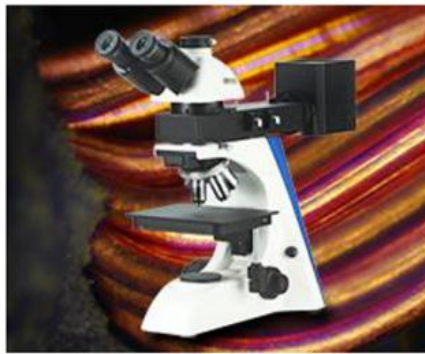

A13.2604-A
Metallurgical Microscope Reflect



A13.2604-B
Metallurgical Microscope Reflect & Transmit



A15.2601-R
Polarizing Microscope Reflect



A15.2601-T
Polarizing Microscope Transmit



A12.2602
A12.2603 Upgraded From A12.2602

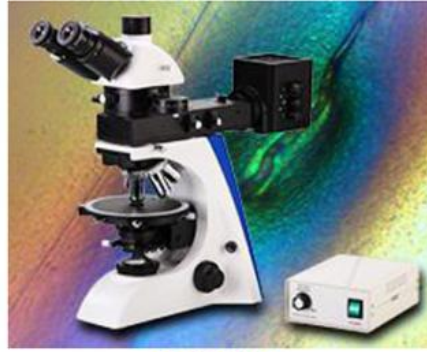

A15.2601-RT
Polarizing Microscope Reflect & Transmit



A16.2603
Fluorescence Microscope



A16.2603-L
LED Fluorescence Microscope



Opto-Edu (Beijing) Co., Ltd.

☎ 0086 13911110627

✉ sale@optoedu.com

🌐 cnoec.com

F-1501 Wanda Plaza, No. 18 Shijingshan Road, Beijing 100043, China