



## Full Motorized Opto Edu Microscope Semi APO BF / PH / PL / FL / DIC

Our Product Introduction

for more products please visit us on cnoec.com

### Basic Information

- Place of Origin: China
- Brand Name: CNOEC, OPTO-EDU
- Certification: CE, Rohs
- Model Number: A16.1098
- Minimum Order Quantity: 1 pc
- Price: Negotiation
- Packaging Details: Carton Packing, For Export Transportation
- Delivery Time: 5~20 Days
- Payment Terms: T/T, West Union, Paypal
- Supply Ability: 5000 pcs/ Month



### Product Specification

- Eyepiece: SW10x/22mm, High Eyepoint, Diopter Adjustable, Dia.30mm
- Nosepiece: Motorized Coded Manual Sextuple Nosepiece, With DIC Slot
- Objective: N-iPLFN PH Infinity Plan Semi-APO Phase Contrast Objective
- Focusing: Motorized Z Axes (Optical Grating Type) Focusing System
- Working Stage: Motorized X/Y Axes (Optical Grating Type) Mechanical Stage
- Condenser: Motorized Long Working Distance Turret Condenser, N.A.0.55
- Highlight: **Full Motorized opto edu microscope, Semi APO opto edu microscope, BF opto edu microscope**



### More Images

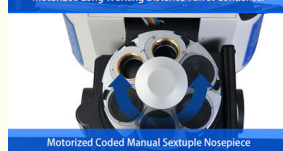
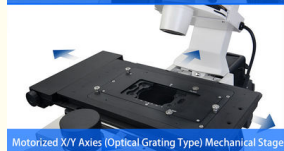

## Product Description

Research Level Full Motorized Inverted Fluorescent Microscope For BF/PH/FL/DIC  
Motorized Sextuple Nosepiece With DIC Slot, Infinity Plan Sem-APO PH10x20x40x  
Motorized Triple Layer Working Stage Moving Range 130x85mm, With 3 Holder  
Motorized LWD Condensor N.A.0.55 W.D.26mm, With 6 Holes Phase Contrast Disc  
Motorized 6 Position Fluorescent Disc, With 3 Filters



OPTO-EDU (BEIJING) CO., LTD.

F-1501 Wanda Plaza, No.18 Shijingshan Road, Beijing 100043, China  
Tel:+8610 88696020 Fax:+8610 88696085

## A16.1098

### Full Motorized Inverted Fluorescent Microscope Semi-APO, BF/PH/PL/FL/DIC



**A14.109-6&7, A16.109-6&7, A16.1098 Series Microscope**

**A14.1096**  
Inverted Laboratory  
Microscope, Semi-  
APO,  
BF/DF/PH/PL/DIC

**A14.1097**  
Inverted Laboratory  
Microscope, LCD Touch  
Screen, Semi-APO,  
BF/DF/PH/PL/DIC

**A16.1096**  
Inverted Fluorescent  
Microscope, Semi-APO,  
BF/PL/PH/FL/DIC

**A16.1097**  
Inverted Fluorescent  
Microscope, LCD Touch  
Screen Semi-APO,  
BF/PL/PH/FL/DIC

**A16.1098**  
Full Motorized Inverted Fluorescent  
Microscope, Semi-APO, BF/PH/PL/FL/DIC

The diagram illustrates the progression of microscope models. At the top left is the A14.1096, a standard inverted laboratory microscope. An arrow points to the A14.1097, which features an LCD touch screen. From there, an arrow points down to the A16.1096, an inverted fluorescent microscope. Another arrow points to the A16.1097, which adds a full motorized stage and a second LCD touch screen. Finally, an arrow points to the A16.1098, a full motorized inverted fluorescent microscope. This model is shown with a computer system, including a monitor displaying a red and blue fluorescent image of cells, a keyboard, a mouse, and a power supply unit.

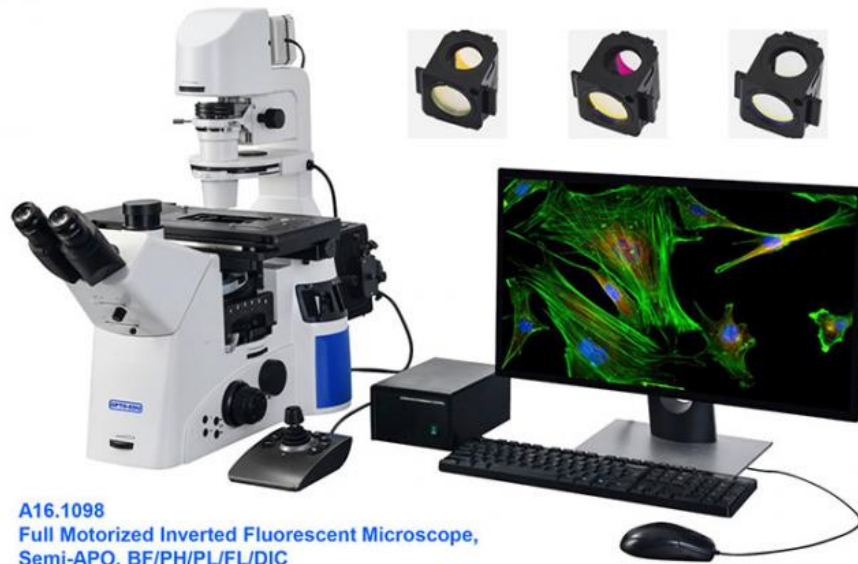

**A16.1098**  
**Full Motorized Inverted Fluorescent Microscope,**  
**Semi-APO, BF/PH/PL/FL/DIC**



**Medial Changeable Lens**

**Transmit/Reflect  
 Illumination Switch Knob**

**4.3 " LCD Information Touch Screen (A14.1097)**

**Medial Changeable Lens**

With built-in turret structure, 1x and 1.5x lens can be changed accordingly

**4.3" LCD Information Touch Screen (A14.1097)** In Front of Main Body, For Easy Watch & Control in The Dark Working Condition.

- Show Objectives In Use In Nosepiece
- Show Cubes In Use In Multi Function Turret
- Brightness Memorize & Restore Function
- Touch To Adjust Brightness
- Touch To Set The System

**Transmit/Reflect Illumination Switch Knob**

The illumination control knobs to switch transmit / epi-fluorescent reflect illumination are located on the right side of main body, for easy operation



Motorized Z Axes (Optical Grating Type) Focusing System

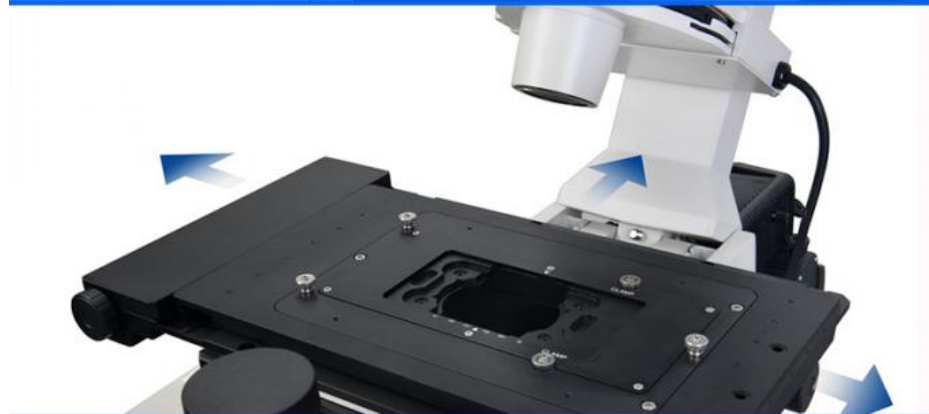

Motorized X/Y Axes (Optical Grating Type) Mechanical Stage

**Focusing**

Motorized Z Axes (Optical Grating Type) Focusing System, Focusing Range 9mm (Up 7mm, Down 2mm), Focusing Resloution 0.02um With Optical Grating, Movement Repeat Positioning Accuracy +/-0.1um, Prevent Stage Fall Down Function

**Working Stage**

**Motorized X/Y Axes (Optical Grating Type) Mechanical Stage**, Size 325x144mm, Moving Range 130x100mm, Max Speed 10mm/s, Resolution 0.1um, Repeat Accuracy +/-0.5um, Available For Different Size Small Stage Mounted on Top Layer, With Separate Communication/Main Control Box & Stick



**Condenser**

Motorized Long Working Distance Turret Condenser, N.A.0.55, W.D.26mm, With 6 Positions For Phase Contrast Annulus, DIC Annulus, And Bright Field View

**Nosepiece**

Motorized Coded Manual Sextuple Nosepiece, With DIC Slot, With Objective Protection Function When Switch The Objectives



**Fluorescent mercury lamp power box**

The intelligent fluorescent mercury lamp power box adopts air-cooled design, with low noise and stable voltage. The unique automatic memory usage time and shutdown time can ensure that the mercury lamp is fully cooled to the greatest extent, protect the life of the mercury lamp, and improve the mechanical efficiency

**Joystick Module**

Flexible positioning of electric stage

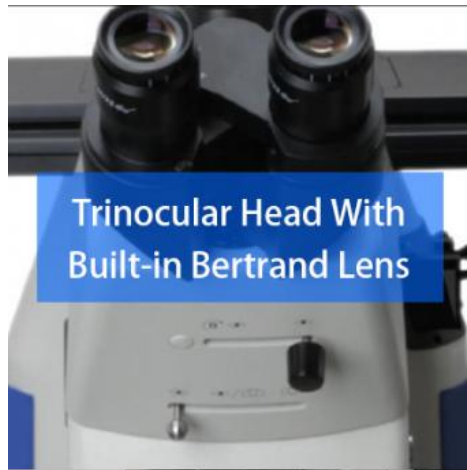

**Trinocular Head With  
Built-in Bertrand Lens**



**Long Working Distance  
Turret Condenser**



**Three Layer  
Mechanical Stage**



**Flexible Transmit  
Illuminator**

**Trinocular Head With Built-in Bertrand Lens**

The built-in bertrand lens can observe the pupil of the objective lens when moving into the light path, and act as a centering telescope

**Flexible Transmit Illuminator**

With retroverted Illuminator, thereby ensuring large space for operation and sample exchange

**Long Working Distance Turret Condenser**

LWD turret structure, with 6 positions for phase contrast annulus, DIC annulus, & bright field view, meets various test needs. condenser N.A.0.55, W.D.26mm





**Camera Adapter At Both Sides & Trinocular Head**

The optical path output selection dial can distribute the optical images to different ports, providing expansion space for more optical image applications



### Simple And Fast Operation, Iris Slider

Reflective field diaphragm, aperture diaphragm and filter plate, three different types of diaphragm sliders show the versatility of A16.1098 in in vivo cell research. When the aperture diaphragm and the fluorescence filter insert are used together, the fluorescence intensity can be adjusted to the most ideal according to the selected fluorescence module and objective lens

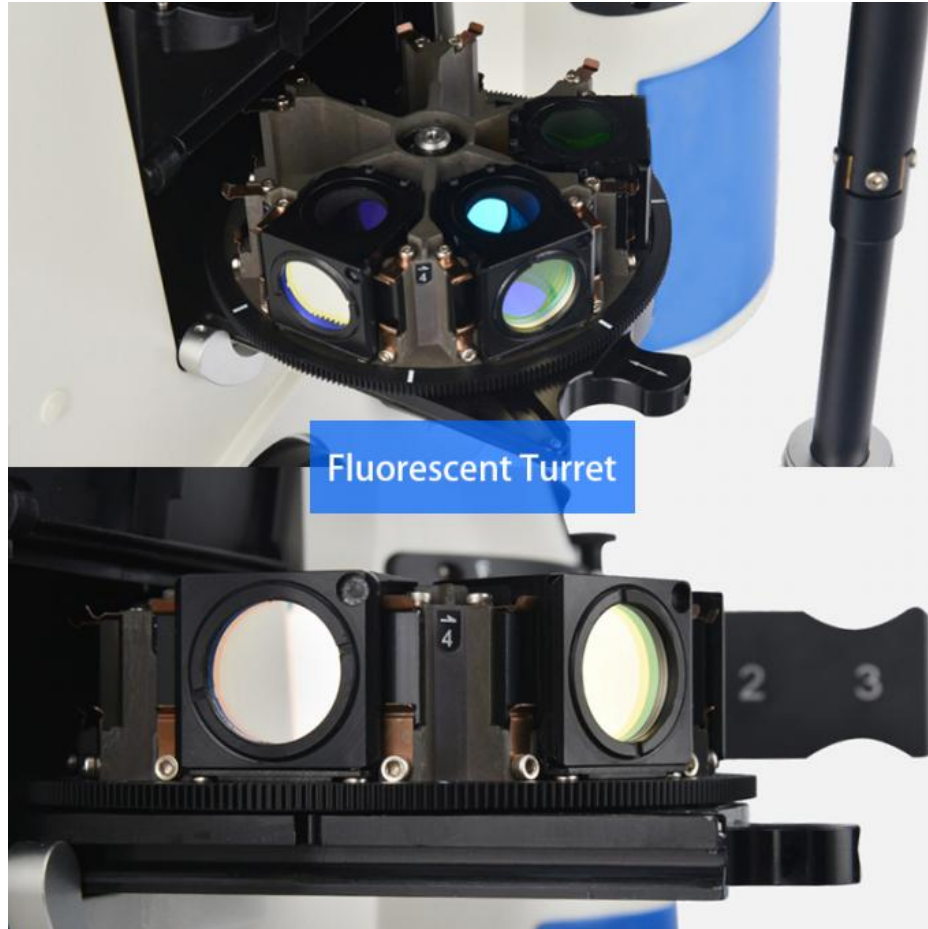

### Fluorescent Turret

Fluorescence excitation module turntable type: easier and more flexible

It adopts multifunctional six-station turntable structure: it can be easily taken out from the host, and it is convenient to replace various fluorescence excitation modules



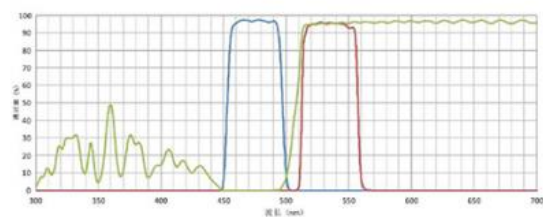
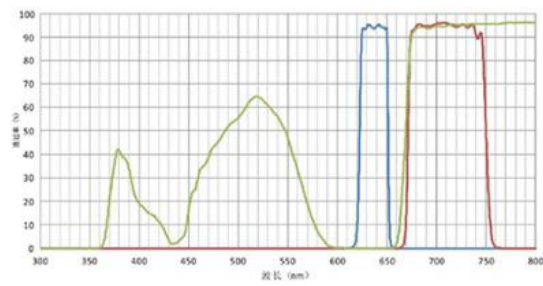
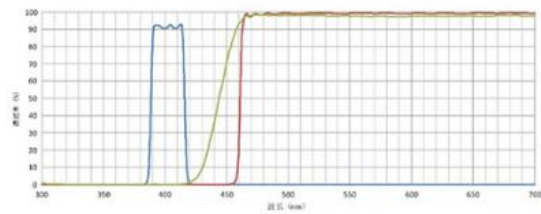
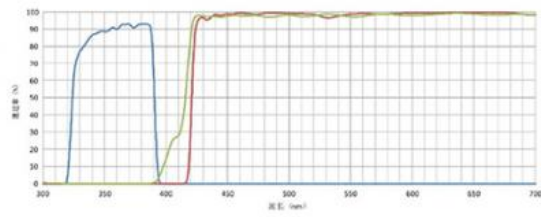
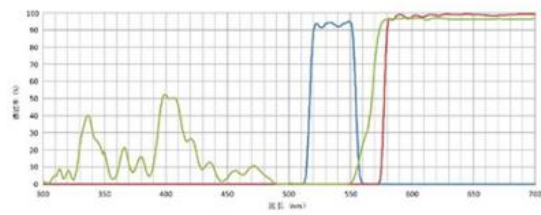
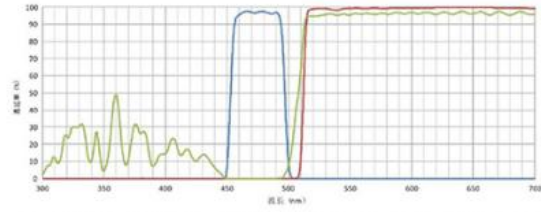
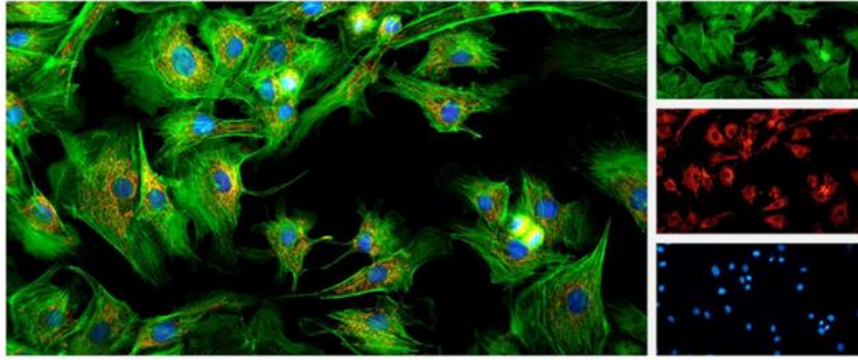

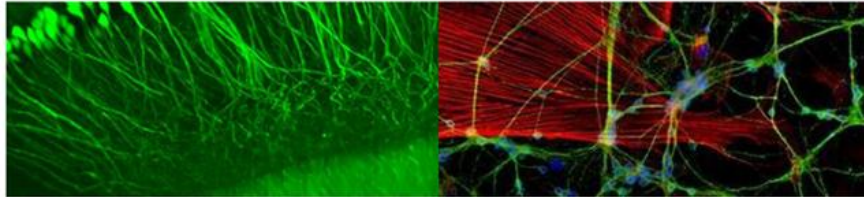
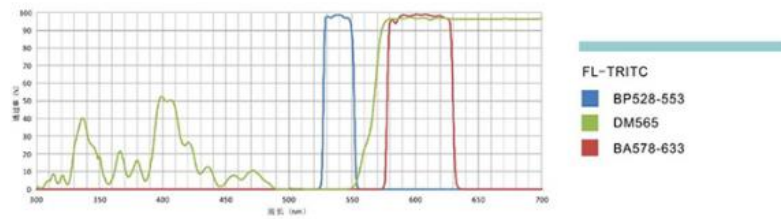
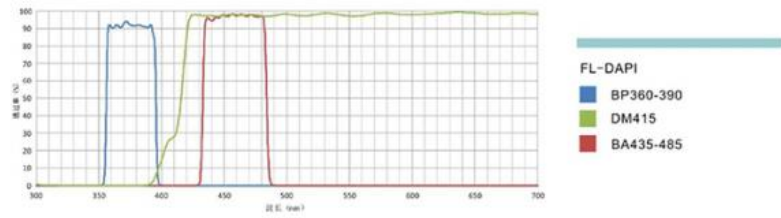

## Modular Design

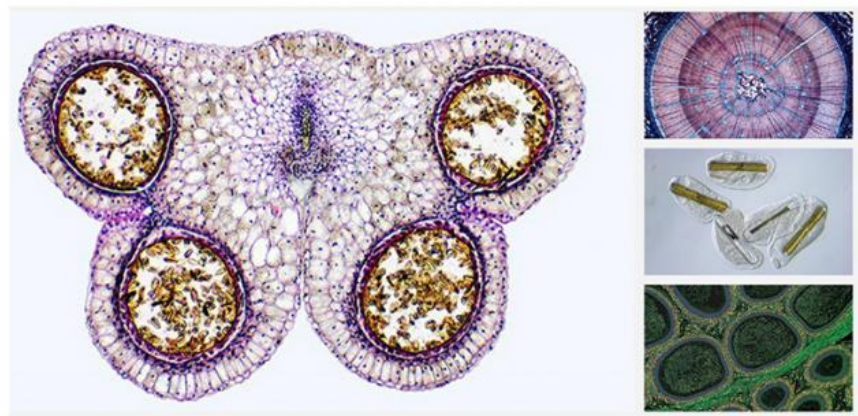

### ◆ Bright Field Observation

Unique infinity optical system, combined with semi-apochromatic fluorescent objective lens, effectively eliminates field curvature, chromatic aberration, spherical aberration, coma and other imaging problems, the image is brighter, all magnifications can achieve higher super-resolution and flat type

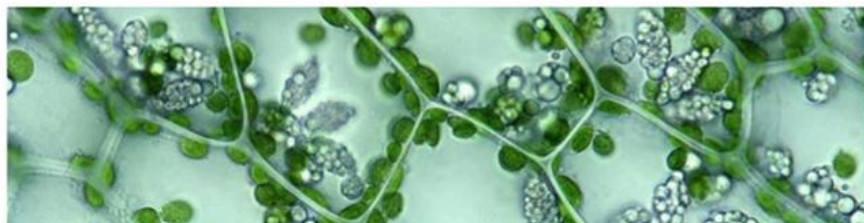

### ◆ Phase Contrast Observation

Phase contrast is an optical contrast technology that uses a phase contrast objective lens and a condenser ring. The high-efficiency halogen lamp can provide a bright light source and obtain clear images even at high magnification

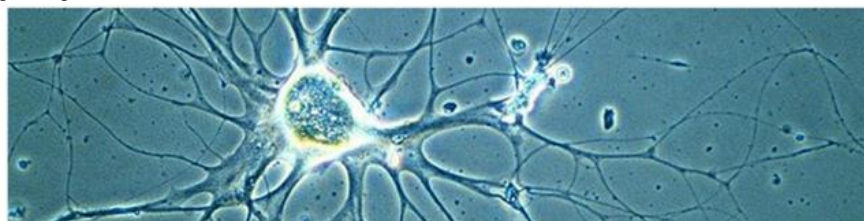

◆ DIC

It is a very cost-effective optical technology. It does not require expensive optical components. The relief contrast only uses a brightfield objective lens and two phase contrast adjustment sliders. For thicker samples, such as induced pluripotent stem cells, DIC can provide Three-dimensional glare-free images, while the use of traditional phase contrast observation methods usually appear halo. In addition, DIC can use glass petri dishes, which is a very practical observation technique.



**Product Accessories**

◆ Photo Adapter

Provide 0.4x, 0.5x, 1x C-Mount for users to choose, used to connect camera, camera and other image acquisition systems



◆ A5C.1098 N-iPLFN PH Infinity Plan Semi-APO Phase Contrast Objective

Multi-layer coating technology, semi-apochromatic objective lens can compensate spherical aberration and chromatic aberration from ultraviolet to near infrared. The 20x and 40x semi-apochromatic objectives have a built-in correction ring that can correct for poor coverage caused by nonstandard cover glass thickness. Highly sensitive fluorescence performance ensures the sharpness, clarity and color reproduction of collected images



◆ Different Size Small Stage Holders



◆ **Mercury Light Source**

The standard osram 100W HBO ultra-high pressure spherical mercury lamp has large fluorescent brightness and uniform field of view. At the same time, a closing gate is set at the front end of the vertical illuminator, which can cut off the fluorescent lighting at any time to protect the sample



◆ **Metal Halide Light Source**

Optional 75W metal halide light source, bulb life up to 2000 hours. The light intensity is greater, the field of view is brighter and uniform



◆ **LED Light Source**

4-color LED light source, adjustable brightness, bulb life is up to tens of thousands of hours. Low phototoxicity and high friendliness to fine samples such as cells, which solves the problems of traditional mercury lamp fluorescence that require preheating, cooling, and high temperature during use

Research Level Inverted Biological Microscope		A14.1096	A14.1097	A16.1096	A16.1097	A16.1098	Cata.No.
Optical System	NIS60 Infinite Optical System, Semi-APO	●	●	●	●	●	
Observation Method	Bright Field	●	●	●	●	●	
	Dark Field	-	-	○	○	○	
	Phase Contrast	●	●	●	●	●	
	Polarizing	●	●	●	●	●	
	Flourescent	○	○	●	●	●	
DIC	○	○	○	○	○		
LCD Screen	4.3" LCD Information Touch Screen In Front of Main Body, For Easy Use in Dark Working Condition. --Show Objectives In Use In Nosepiece --Show Cubes In Use In Multi Function Turret --Brightness Memorize & Restore Function --Touch To Adjust Brightness --Touch To Set The System	-	●	-	●	○	
Head	Seidentopf Trinocular Head, Inclined 45°, Interpupillary Distance 47-78mm, Ligth Split Switch E100:P0/E20:P80/E0:P100, With Built-in <b>Bertrand</b> Lens Which Can Be Used As Centering Telescope	●	●	●	●	●	
Eyepiece	SW10x/25mm, High Eyepoint, Diopter Adjustable, Dia.30mm	○	○	○	○	○	A51.1090-1025
	SW10x/22mm, High Eyepoint, Diopter Adjustable, Dia.30mm	●	●	●	●	●	A51.1090-1022
	EW12.5x/17.5mm, High Eyepoint, Diopter Adjustable, Dia.30mm	○	○	○	○	○	A51.1090-12516
	WF15x/16mm, High Eyepoint, Diopter Adjustable, Dia.30mm	○	○	○	○	○	A51.1090-1516
	WF20x/12mm, High Eyepoint, Diopter Adjustable, Dia.30mm	○	○	○	○	○	A51.1090-2012
Media Lens	Built-in Media Lens Turret 1.0x, 1.5x, Under Nosepiece	●	●	●	●	-	
	Built-in Media Lens Turret 1.0x, 1.5x. CF, Under Nosepiece	-	-	-	-	●	
Nosepiece	Manual Sextuple Nosepiece, With DIC Slot	●	-	●	-	-	
	<b>Coded</b> Manual Sextuple Nosepiece, With DIC Slot	-	●	-	●	-	
	<b>Motorized Coded</b> Manual Sextuple Nosepiece, With DIC Slot, With Objective Protection Function When Switch The Objectives	-	-	-	-	●	
N-iPLFN PH Infinity Plan Semi-APO	4x/0.13, W.D.16.5mm, No Cover Glass	○	○	○	○	○	A5C.1098-4
	10x/0.30, W.D.7.4mm, Cover Glass 1.2mm	●	●	●	●	●	A5C.1098-10
	20x/0.45, W.D.7.5-8.8mm, Cover Glass 0-2mm, With Built-in Correct Ring	●	●	●	●	●	A5C.1098-20

Phase Contrast Objective	40x/0.6, W.D.3-4.4mm, Cover Glass 0-2mm, With Built-in Correct Ring	●	●	●	●	●	A5C.1098-40
	60x/0.75, W.D.1.8-2.6mm, Cover Glass 0.1-1.3mm, With Built-in Correct Ring	○	○	○	○	○	A5C.1098-60
Focusing	Coaxial Coarse & Fine Focusing, Focusing Range 9mm (Up 7mm, Down 2mm), Coarse Stroke 2mm, Fine Stroke 0.2mm	●	●	●	●	-	
	<b>Motorized Z Axes (Optical Grating Type)</b> Focusing System, Focusing Range 9mm (Up 7mm, Down 2mm), Focusing Resloution 0.02um With Optical Grating, Movement Repeat Positioning Accuracy +/-0.1um, Prevent Stage Fall Down Function	-	-	-	-	●	
Working Stage	Three Layer Mechanical Stage, Moving Range 130x85mm, Flexible Knob, Available For Different Size Small Stage Mounted on Top Layer	●	●	●	●	-	A54.1098
	<b>Motorized X/Y Axes (Optical Grating Type)</b> Mechanical Stage, Size 325x144mm, Moving Range 130x100mm, Max Speed 10mm/s, Resloution 0.1um, Repeat Accuracy +/-0.5um, Available For Different Size Small Stage Mounted on Top Layer, With Separate Communication/Main Control Box & Stick	-	-	-	-	●	A54.1098-M
	Dia.38mm Holder For Slide & Petri Dish	●	●	●	●	●	A54.1098-38
	Dia.54mm Holder For Petri Dish	●	●	●	●	●	A54.1098-54
	96 Holes Plate Holder	●	●	●	●	●	A54.1098-96
	Terasaki Holder	●	●	●	●	●	A54.1098-TH
	Universal Holder	●	●	●	●	●	A54.1098-UH
Condenser	Long Working Distance Turret Condenser, N.A.0.55, W.D.26mm, With 6 Positions For Phase Contrast Annulus, DIC Annulus, And Bright Field View	●	●	●	●	-	A56.1098
	<b>Motorized</b> Long Working Distance Turret Condenser, N.A.0.55, W.D.26mm, With 6 Positions For Phase Contrast Annulus, DIC Annulus, And Bright Field View	-	-	-	-	●	A56.1098-M
Multi Function Turret	Multi Function Turret Under Nosepiece, With 6 Positions For Cubes Of Bright Field, Dark Field, Phase Contrast, Polarizing, Fluorescent View, Turning The Disc To Easily Switch Observation Methods	●	●	●	-	-	
	<b>Coded</b> Multi Function Turret Under Nosepiece, With 6 Positions For Cubes Of Bright Field, Dark Field, Phase Contrast, Polarizing, Fluorescent View, Turning The Disc To Easily Switch Observation Methods	-	-	-	●	-	
	<b>Motorized Coded</b> Multi Function Turret Under Nosepiece, With 6 Positions For Cubes Of Bright Field, Dark Field, Phase Contrast, Polarizing, Fluorescent View, Turning The Disc To Easily Switch Observation Methods	-	-	-	-	●	
Dark Field	Dark Field Block, Put In Multi Function Turret, For Reflect Light Source	○	○	○	○	○	A5D.1098
Polarizing For Transmit Light	Polarizer Filter On LWD Turret Condenser	●	●	●	●	●	A5P.1098-P
	Analyzer Slide, Insert Into Slot On Nosepiece, 360° Rotatable	●	●	●	●	●	A5P.1098-A
Polarizing For Reflect Light	Polarizer Light Block, Put In Multi Function Turret	○	○	○	○	○	A5P.1098-PL
	Circularly Polarized Light Block, Put In Multi Function Turret	○	○	○	○	○	A5P.1098-CP
Phase Contrast	Phase Contrast Annulus 10x/20x, Put In Turret Condenser	●	●	●	●	●	A5C.1096-1020
	Phase Contrast Annulus 40x, Put In Turret Condenser	●	●	●	●	●	A5C.1096-40
	Phase Contrast Annulus 60x, Put In Turret Condenser	○	○	○	○	○	A5C.1096-60
DIC	DIC Annulus 10x, Put In LWD Turret Condenser	○	○	○	○	○	A5C.1097-A10
	DIC Annulus 20x, Put In LWD Turret Condenser	○	○	○	○	○	A5C.1097-A20
	DIC Annulus 40x, Put In LWD Turret Condenser	○	○	○	○	○	A5C.1097-A40
	DIC Annulus 60x, Put In LWD Turret Condenser	○	○	○	○	○	A5C.1097-A60
	DIC Slider 10x, Insert Into Slot On Nosepiece	○	○	○	○	○	A5C.1097-S10
	DIC Slider 20x, Insert Into Slot On Nosepiece	○	○	○	○	○	A5C.1097-S20
	DIC Slider 40x, Insert Into Slot On Nosepiece	○	○	○	○	○	A5C.1097-S40
DIC Slider 60x, Insert Into Slot On Nosepiece	○	○	○	○	○	A5C.1097-S60	

Illumination	Transmit/Reflect Illumination Switch Knob, On Right Side Of Main Body, Press To Switch Transmit And Reflect Switch Light Quickly	●	●	●	●	●	
Transmit Light Source	12V100W Halogen Kohler Illumination, Brightness Adjustable, Flexible Illuminator Body Can Retrovert From Optical Path For Large Space of Operation And Sample Exchange	●	●	●	●	●	A56.1095-12V100W
	10W S-LED Kohler Illumination, Brightness Adjustable	○	○	○	○	○	A56.1095-10WLED
Reflect Light Source	Large Filter Holder Slide With 3 Holes	○	○	●	●	●	A56.1095-LS
	Field Diaphragm Slide, Center Adjustable,	○	○	●	●	●	A56.1095-FS
	Small Empty Slide	○	○	●	●	●	A56.1095-ES
	Aperture Diaphragm Slide	○	○	●	●	●	A56.1095-AS
	Neutral Filter	○	○	●	●	●	A56.1095-NE
Reflect Fluorescent Light Source	Reflect 100W Osram Mercury HBO Fluorescent Light House Intelligent Power Supply Control Box With Barrier To Stop/Recover Fluorescent Illumination Quickly	○	○	●	●	●	A5F.1095-100W
	10W S-LED Fluorescent Light, 4 Color Bands, Brightness Adjustable By Control Box	○	○	○	○	○	A5F.1095-10WLED
	75W Metal Halide Light Source, Life Time 2000 Hours	○	○	○	○	○	A5F.1095-75WM
	Fluorescent Filter B Block, Put In Multi Function Turret	○	○	●	●	●	A5F.1095-B
	Fluorescent Filter G Block, Put In Multi Function Turret	○	○	●	●	●	A5F.1095-G
	Fluorescent Filter U Block, Put In Multi Function Turret	○	○	●	●	●	A5F.1095-U
	Fluorescent Filter V Block, Put In Multi Function Turret	○	○	○	○	○	A5F.1095-V
Metallurgical	Upgrade To <b>A13.1090</b> Inverted Metallurgical Microscope	○	○	○	○	○	<b>A13.1090</b>
Adapter	3 Camera Ports, On Both Side Of Main Body And Head, Turret Switch Between: --Trinocular Port Switch E100:P0/E20:P80/E0:P100 --Left Port C-Mount 1.0x E0:P100 --Right Port C-Mount 1.0x E20:P80	●	●	●	●	●	
	C-Mount 0.4x	○	○	○	○	○	A55.1095-04
	C-Mount 0.5x	○	○	○	○	○	A55.1095-05
	C-Mount 1.0x	●	●	●	●	●	A55.1095-10
Software	NOMIS Basic Image Processing Software	○	○	○	○	○	A30.1090

Note: "●" In Table Is Standard Outfits, "○" Is Optional Accessories "-" Is Unavailable

## Software Function

### ◆ Measurement Function

In cell observation and section observation, you need to use the measurement function. To determine the cell size, cell gap, synapse length and other data. The software can provide measurement of distance, angle, rectangle, circle, ellipse, etc.



### ◆ Cell Counts

Customize cell counting requirements, automatically count and count the shape information of cells, including: size, location, volume, circumference, brightness, etc. And all data including processed images can be saved as excel sheet



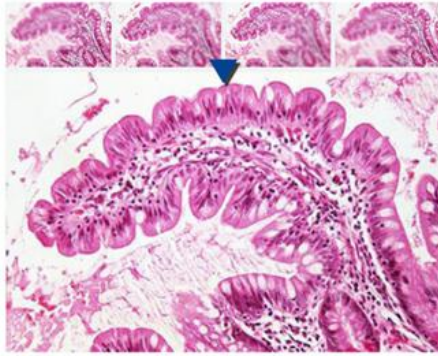

◆ **Depth Of Field Fusion**

Users can collect multiple images with different focal lengths by fine-tuning the focal length, and synthesize one image for output. Suitable for specimens that require a certain depth of field or poorly made sections

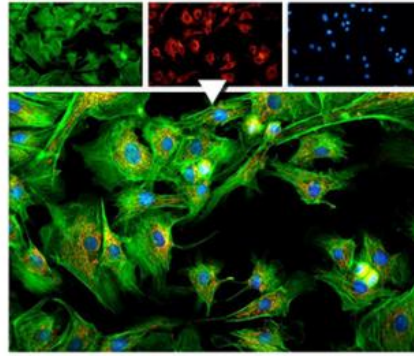

◆ **Fluorescence image synthesis**

By collecting or importing images of different fluorescence channels, users can obtain images after fluorescence synthesis. For the image of each channel, the displacement in the x direction and y direction can be adjusted to achieve the fine-tuning effect

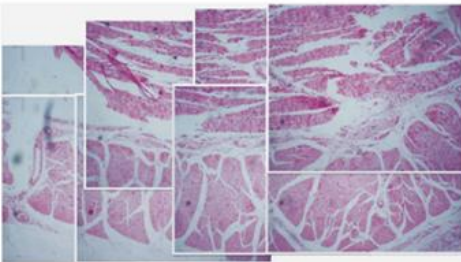

◆ **Quick Splicing**

By collecting and importing images in real time, the software can quickly stitch together to form a large-size and high-resolution image

**System Diagram & Size(mm)**

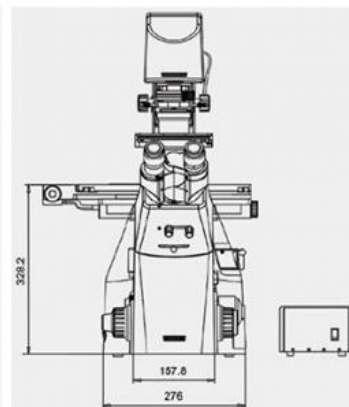
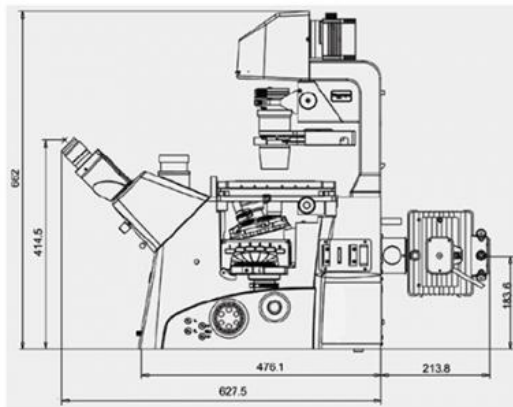

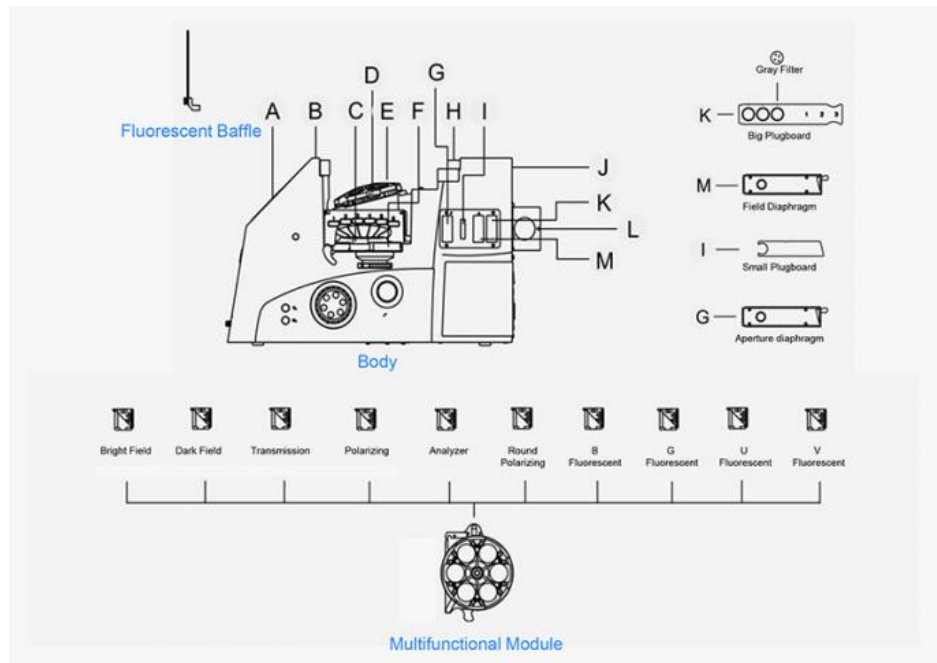
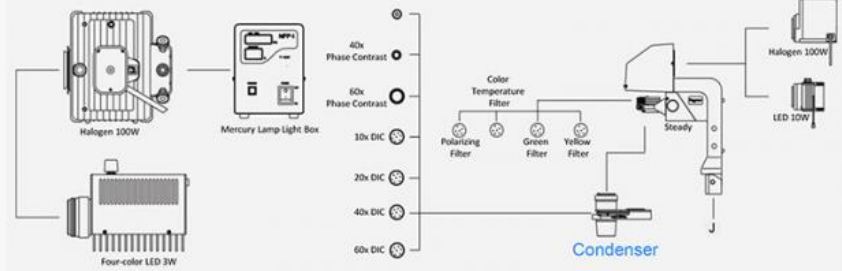
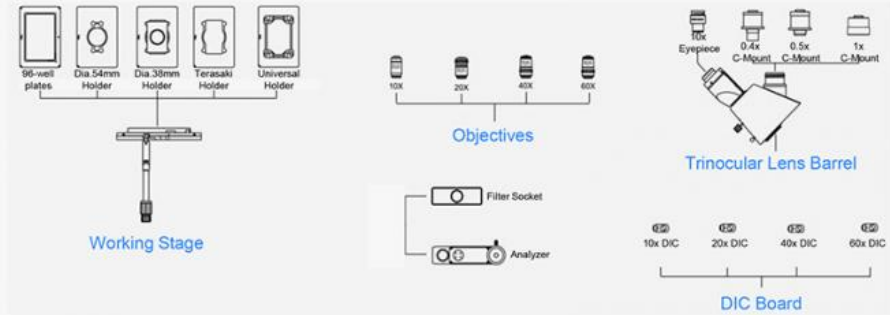

Opto-Edu (Beijing) Co., Ltd.

☎ 0086 13911110627    ✉ sale@optoedu.com    🌐 cnoec.com

F-1501 Wanda Plaza, No. 18 Shijingshan Road, Beijing 100043, China