



## OPTO EDU A16.1064 Inverted Fluorescent Microscope B G U Long Working Distance

Our Product Introduction

### Basic Information

- Place of Origin: China
- Brand Name: CNOEC, OPTO-EDU
- Certification: CE, Rohs
- Model Number: A16.1064
- Minimum Order Quantity: 1 pc
- Price: Negotiation
- Packaging Details: Carton Packing, For Export Transportation
- Delivery Time: 5~20 Days
- Payment Terms: T/T, West Union, Paypal
- Supply Ability: 5000 pcs/ Month



### Product Specification

- Head: Seidentopf Viewing Head, Inclined At 45°
- Eyepiece / F.O.V: EW10x/22mm, Diopter Adjustable, Dia.30mm
- Nosepiece: Coded Quintuple Nosepiece, Dovetail Interface
- Objective: LWD Infinity Plan Semi-APO Fluorescent Objective
- Working Stage: Plain Working Stage 170(X) X 250(Y)mm,
- Condenser: Long Working Distance Detachable Condenser NA 0.3
- Highlight: **opto edu inverted fluorescent microscope, inverted fluorescent microscope opto edu, CE inverted fluorescent microscope**



for more products please visit us on [cnoec.com](http://cnoec.com)

## Product Description

Brand New Design 2019 High Level Inverted Fluorescent Microscope  
Epi-Fluorescence Attachment, Turret With 3 Holes For Filter Cubes B,G,U Bands  
Super Long Working Distance Upto 187mm Condenser  
Coded 5 Holes Nosepiece With LCD Screen And Auto Brightness Adjust Function  
Phase Contrast, Hoffman Contrast, Emboss Contrast (DIC) Optional

OPTO-EDU (BEIJING) CO., LTD.

OPTO-EDU



### A16.1064 Inverted LED Fluorescent Microscope

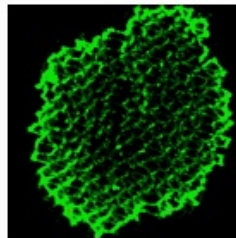

Bright Field  
Phase Contrast  
Hoffman Phase Contrast  
DIC Emboss Contrast  
Epi-Fluorescent

3W LED  
Kohler Illumination  
Detachable Abbe  
Condenser

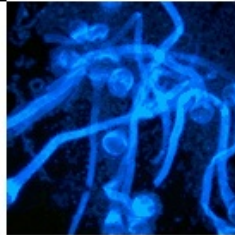

Creative LCD  
Screen With  
Coded Nosepiece  
& ECO Function



Our Product Introduction

for more products please visit us on [cnoec.com](http://cnoec.com)

## Professional Cell Observation

	A16.1063	A16.1064
Observation	Bright Field, Phase Contrast, Hoffman Phase Contrast, DIC Emboss Contrast, Epi-Fluorescent	
Nosepiece	Quintuple	Coded Quintuple
Illumination	3W LED	3W LED Kohler
LCD	--	Yes
ECO	--	Yes, 15 Mins Auto Off



### Ergonomic Design, Comfortable Operation

#### 45° Inclined Viewing Head Inclined

Viewing Head Makes The User To Operate Microscope In A Comfortable Position. Minimize Muscle Tension And Discomfort Caused By Long Working Hours.

#### Long-handle Mechanical Stage

The User Can Make Comfortable And Smooth Movement During The Operation, Thereby Improving Work Efficiency And Comfort.



### High Brightness, Long Lifetime LED Illumination

LED Illuminator, Suitable For Various Observation, With A High Brightness And Long Lifetime Led Illumination System For Both Transmission And Fluorescent Lighting, Proving Even Brightness And Cool Lighting.

### Intelligent Operating System

#### Objective Coding Converter

It Can Memorize The Illumination Brightness When Using Each Objective. When Different Objectives Are Converted To Each Other, The Light Intensity Is Automatically Adjusted To Reduce Visual Fatigue And Improve Work Efficiency.



### Use A Dimming Knob To Achieve Multiple Functions

Click: Enter Standby Status, Press + Up-spin: Switch To The Upper Light Source; Double Click: Light Lock Or Unlock, Press + Down-spin: Switch To The Under Light Source; Rotation: Adjust Brightness, Press 3 Seconds: Set The Time Of Turning Off The Light After Leaving.



## Fluorescent Observation

### LED Light Makes Fluorescent Observation Easier

#### • Uniform Brightness

Matching With Kohler Illumination, The Fly-eye Lens Delivers Uniform Brightness To The Entire Filed Of View, Whether Through The Eyepiece Or Through CCD Camera.

#### • LED Easy To Use

Compared With The Traditional Mercury Bulb, The Led Eliminate Frequent Bulb Replacements, Saving Time And Money. Also The Problems Of Preheating, Cooling And High Temperature Is Solved.



### Suitable For A Variety Of Fluorescent Dyes

Equipped With 3 Fluorescent Filter Blocks, It Provides A Wide Range Of Choice Of Dyes And Capture Clear High Contrast Fluorescence Images.

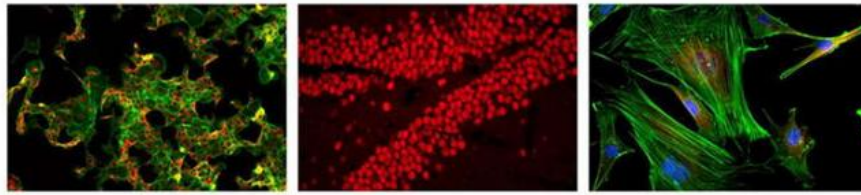

Breast Cancer

Hippocampus

HC3T3 Mouse Brain Nerve Cells

### Contrast Shield

The Contrast Shield Can Effectively Block The Interference Of The External Light, Increase The Contrast Of The Fluorescent Image, And Provide A High Signal-to-noise Ratio Fluorescent Image. When Need Phase Contrast Observation, The Contrast Shield Is Very Convenient To Be Removed From The Light Path, Avoiding Influence On The Quality Of Phase Contrast.

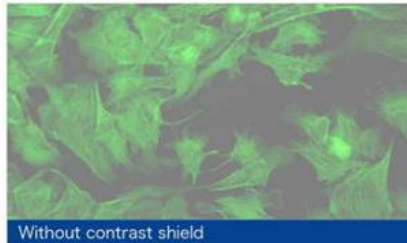

Without contrast shield

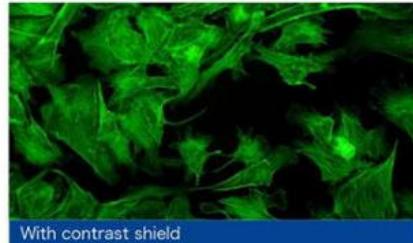

With contrast shield

## Convenient For Cell Sampling And Aseptic Manipulation

### The Microscope Control Mechanism Is Reasonable In Layout And Easy To Operate

The Frequently Used Control Mechanisms Are Close To The User And In Low-hand Position. This Kind Of Design Makes Operation More Quickly And Conveniently, And Reduce The Fatigue Caused By The Long Observation. On The Other Hand, It Reduces The Airflow And Dust Caused By Large Amplitude Operation, And It Is Very Effective To Reduce The Probability Of Sample Pollution. It Is A Strong Guarantee For The Accuracy And Repeatability Of The Experimental Results.



### The Body Is Compact, Stable And Suitable For Clean Bench

#### Can Be Sterilized In The Clean Bench

On The Premise Of Ensuring The Effect Of Imaging, A16.1063 Is With Relative Compact Design. The Volume And Weight Of The Body Is Reduced As Much As Possible In Principle Of Stability. The Compact Body Is With Anti-UV Coating And Can Be Placed Into The Clean Bench For Sterilization Under UV Lamp.



#### Cell Sampling And Operation Can Be Performed In Clean Bench

The Distance Between The Eye Point To The Operation Button And The Focusing Knob Of The A16.1063 Is Relatively Short, And The Distance From The Stage Is Far Away. It Is Available To Make The Viewing Head And Operating Mechanism Outside, And Stage, Objectives And Sample Inside. So Realize Cell Sampling And Operation Inside And Observing Comfortably Outside.

### Various Holders For Different Culture Containers

Various Holders Are Available For Different Culture Containers, Such As Petri Dishes, Well Plates, And Culture Flasks. As Well As Available For Different Size Petri Dishes.



### Detachable Condenser

When Culture Flask Is Used, The Condenser Can Be Removed To Increase Working Distance. It Is Also Suitable For Multilayer Culture Flask.



## Transmission

### Phase Contrast

By Using Changes In The Refractive Index, High Contrast Microscopic Images Of Transparent Samples Can Be Obtained With Phase Contrast Observation Technique. The Advantage Is That The Details Of Live Cell Imaging Can Be Obtained Without Staining And Fluorescent Dyes.

Application Range: Living Cells In Culture, Microorganism , Tissue Slide , Subcellular Grains (including Cell Nuclei And Organelles).

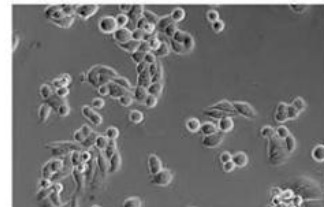
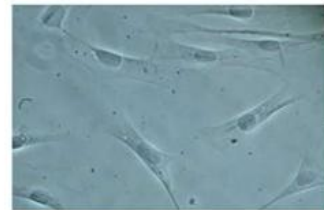

### Hoffman Modulation Phase Contrast

With Slant Light, Changing Phase Gradient Into Light Intensity Variety, It Can Be Used To Observe Unstained Cells And Living Cells.



### DIC 3D Emboss Contrast

Even Without Extra Optical Components, No Glare 3D Image Can Be Obtained Just Through Adding Adjustment Slider. Both Glass And Plastic Petri Dishes Are Available.



A14.1063, A14.1604 Inverted Biological Microscope, A16.1063, A16.1064 Inverted LED Fluorescent Microscope		A14.1 063	A14.1 064	A16.1 063	A16.1 064	Cata. No.
Optical System	NIS60 Infinite Optical System (F200)	•	•	•	•	
	Bright Field,	•	•	•	•	
	Phase Contrast	•	•	○	○	

Observation Method	Epi-Fluorescence	○	○	●	●	
	DIC 3D Emboss Contrast	○	○	○	○	
	Hoffman Phase Contrast	○	○	○	○	
Head	Seidentopf Viewing Head, Inclined At 45°, Interpupillary Distance 48-75mm, Eyepiece Tube Dia.30mm	●	●	●	●	
Eyepiece / F.O.V	EW10x/22mm, Diopter Adjustable, Dia.30mm	●	●	●	●	A51.1030-1022
	EW15x/16mm, Diopter Adjustable, Dia.30mm	○	○	○	○	A51.1030-1516
	EW20x/12mm, Diopter Adjustable, Dia.30mm	○	○	○	○	A51.1030-2012
Nosepiece	Quintuple Nosepiece, Dovetail Interface	○	-	●	-	
	Coded Quintuple Nosepiece, Dovetail Interface	-	●	-	●	
LWD Infinity Plan Objective	4x/0.10, W.D.30.0mm	●	●	○	○	A5M.1032-4
	10x/0.25, W.D.10.2mm	○	○	○	○	A5M.1032-10
	20x/0.40, W.D.12.0mm	○	○	○	○	A5M.1032-20
	40x/0.60, W.D.2.20mm	○	○	○	○	A5M.1032-40
LWD Infinity Plan Phase Contrast Objective	4x/0.10, W.D.30.0mm	○	○	○	○	A5C.1038-4
	10x/0.25, W.D.10.2mm	●	●	○	○	A5C.1038-10
	20x/0.40, W.D.12.0mm	●	●	○	○	A5C.1038-20
	40x/0.60, W.D.2.20mm	●	●	○	○	A5C.1038-40
LWD Infinity Plan Semi-APO Phase Contrast Objective	4x/0.13, W.D.17.0mm	○	○	○	○	A5C.1039-4
	10x/0.3, W.D.7.4mm	○	○	○	○	A5C.1039-10
	20x/0.45, W.D.8.0mm	○	○	○	○	A5C.1039-20
	40x/0.60, W.D.3.6mm	○	○	○	○	A5C.1039-40
	20x/0.45, W.D.7.5-8.8mm With Iris Adjustable	○	○	○	○	A5C.1040-20
	40x/0.60, W.D.3.0-4.4mm With Iris Adjustable	○	○	○	○	A5C.1040-40
	60x/0.70, W.D.1.8-2.6mm With Iris Adjustable	○	○	○	○	A5C.1040-60
LWD Infinity Plan Semi-APO Fluorescent Objective	4x/0.13, W.D.17.0mm, Cover Glass -	-	-	●	●	A5F.1032-4
	10x/0.30, W.D.7.4mm, Cover Glass1.2mm	-	-	●	●	A5F.1032-10
	20x/0.45, W.D.8.0mm, Cover Glass1.2mm	-	-	●	●	A5F.1032-20
	40x/0.60, W.D.3.3mm, Cover Glass1.2mm	-	-	●	●	A5F.1032-40
	60x/0.70, W.D.1.8-2.6mm, Cover Glass1.2mm	○	○	○	○	A5F.1032-60
Focusing System	Coaxial Coarse & Fine Adjustment, Tension Adjustable (At Right Hand), Fine Division 0.002mm, Coarse Focusing Range Up 7mm, Down 1.5mm, Max Up To 18.5mm After Removing Focusing Limit.	●	●	●	●	
Working Stage	Plain Working Stage 170(X) x 250(Y)mm,	●	●	●	●	
	Attachable Mechanical Moving Stage, X-Y Coaxial Moving 128x80mm	●	●	●	●	A54.1063-XY
	Stage Clip	●	●	●	●	A54.1063-SC
	Well Clamper For Well Plate	●	●	●	●	A54.1063-WC
	Glass Stage Plate	●	●	●	●	A54.1063-G
	Metal Stage Plate For Culture Bottle	○	○	○	○	A54.1063-M
	Auxilliary Plate 2 Pieces (1 Piece Each Side)	●	●	●	●	A54.1063-A
	Universal Holder	●	●	●	●	A54.1063-U
	Terasaki Holder	○	○	○	○	A54.1063-T
	Dia.35mm Petri Dish Holder	○	○	○	○	A54.1063-35
	Dia.54mm Slide & Petri Dish Holder	○	○	○	○	A54.1063-54
	Dia.65mm Slide & Petri Dish Holder	○	○	○	○	A54.1063-65
Dia.90mm Petri Dish Holder	○	○	○	○	A54.1063-90	
Condenser	Long Working Distance Detachable Condenser NA 0.3, W.D.75mm, Without Condenser W.D.187mm	●	●	●	●	
Illumination	Transmitted Illumination 3W S-LED Critical Illumination	●	-	●	-	
	Transmitted Illumination 3W S-LED Kohler Illumination	-	●	-	●	
	Reflected Illumination 3W LED, For Epi-Fluorescence	○	○	●	●	
Phase Contrast	Centering Telescope 10x, Tube Dia. 30mm	●	●	○	○	A5C.1063-T
	Phase Slider For 4x//10x-20x-40x	●	●	○	○	A5C.1063-S
	Phase Slider For 10x-20x,40x APO Objectives	○	○	○	○	A5C.1063-APOS1
	Phase Slider For 4x,60x APO Objectives	○	○	○	○	A5C.1063-APOS2
Emboss Contrast DIC	Emboss Contrast Slider For 10x-20x-40x	○	○	○	○	A5C.1063-DIC
	Universal Emboss Contrast Plate For 10x-20x-40x					
Hoffman Phase Contrast	Hoffman Phase Contrast Set: --Hoffman Phase Contrast Condenser, With Polarizer, --Hoffman Phase Contrast Objective 10x, 20x, 40x --Hoffman Phase Slider For 10x, 20x, 40x --Centering Telescope 10x, Tube Dia. 30mm	○	○	○	○	A5C.1064
Epi-Fluorescence Attachment	Epi-Fluorescence Attachment, Turret With 3 Holes For Filter Cubes, With Noise Terminator Mechanism, With Attachable UV Shield	○	○	●	●	
	Filter Cube B + LED Unit, 365nm	○	○	●	●	A5F.1063-B
	Filter Cube G + LED Unit, 405nm	○	○	●	●	A5F.1063-G
	Filter Cube U + LED Unit, 485nm	○	○	●	●	A5F.1063-U
	Filter Cube V + LED Unit, 525nm	○	○	○	○	A5F.1063-V
	Filter Cube FITC					A5F.1063-FITC
Filter Cube DAPI					A5F.1063-DAPI	

	Filter Cube TRITC					A5F.1063-TRITC
Photo Port	Head Side Camera Port Switchable 100/0:0/100	●	●	●	●	
Photo Adapter	1.0x C-Mount	●	●	●	●	A55.1063-1.0
	0.5x C-Mount	○	○	○	○	A55.1063-0.5
	0.7x C-Mount	○	○	○	○	A55.1063-0.7
Power Supply	AC 100-240V,50/60Hz	●	●	●	●	
ECO Function	Auto Power Off 15 Minutes After No Operator Working	○	-	○	-	
LCD Screen	LCD Screen On Front Of Body, Display Using State Of Microscope, Including Magnification, Light Intensity, Standby Status, <b>ECO</b> Set Power Off Timer 5 Mins to 8 Hours, And So On.	-	●	-	●	
Dimensions	244(W)x543(D)x526(H) mm	●	●	●	●	

Note: "●" In Table Is Standard Outfits, "○" Is Optional Accessories "-" Is Unavailable

## Dimension Figure

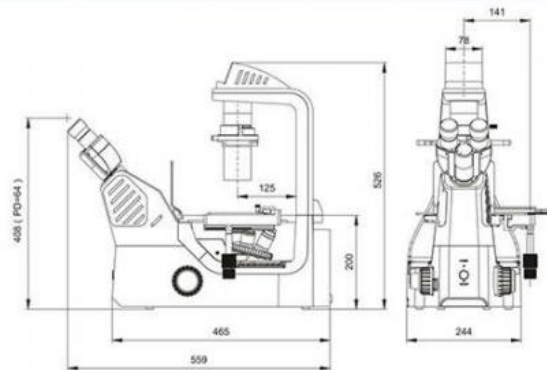

## System Diagram

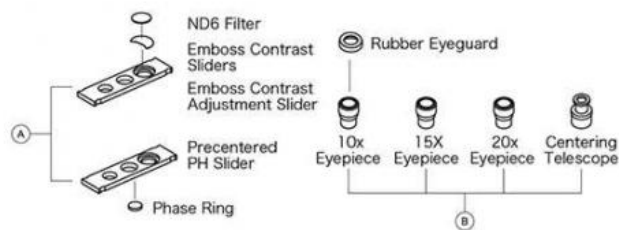
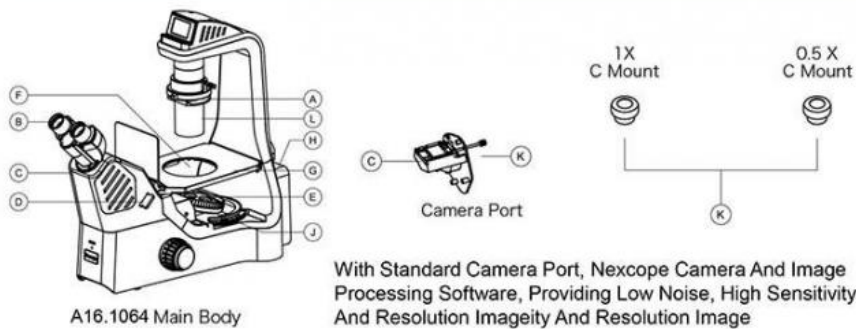

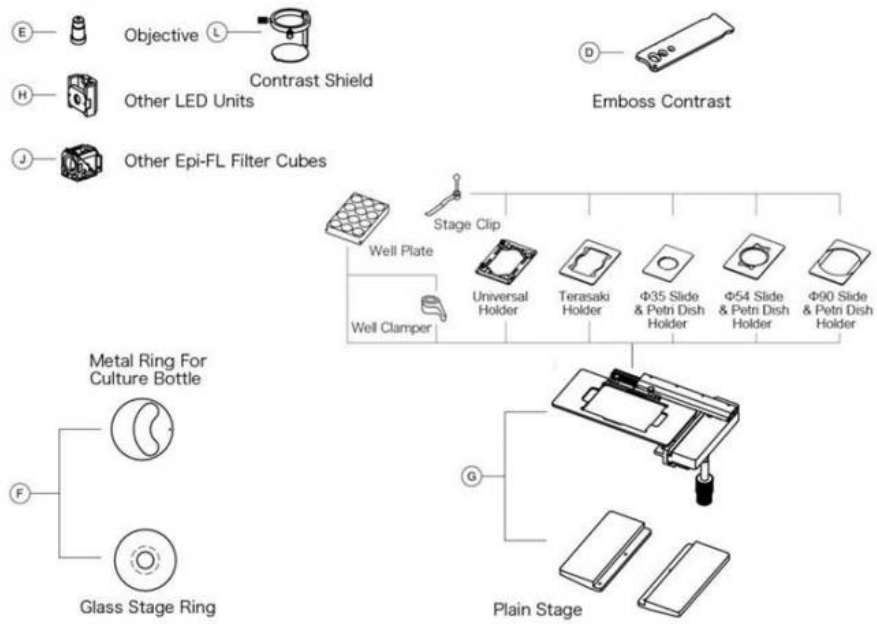

**Opto-Edu (Beijing) Co., Ltd.**

☎ 0086 13911110627

✉ [sale@optoedu.com](mailto:sale@optoedu.com)

🌐 [cnoec.com](http://cnoec.com)

F-1501 Wanda Plaza, No. 18 Shijingshan Road, Beijing 100043, China