



## A12.0909 18mm Eyepiece Opto Edu Microscope Quadruple Achromatic Backward Nosepiece

Our Product Introduction

for more products please visit us on [cnoec.com](http://cnoec.com)

### Basic Information

- Place of Origin: China
- Brand Name: CNOEC
- Certification: CE
- Model Number: A12.0909
- Minimum Order Quantity: 1
- Price: \$1-\$1000
- Packaging Details: Carton
- Delivery Time: 1month
- Payment Terms: T/T, West Union and Paypal
- Supply Ability: 10000



### Product Specification

- Eyepiece: WF10x/18mm
- Nosepiece: Backward, Quadruple Nosepiece
- Condenser: Abbe N.A.1.25, With Iris Diaphragm, Fixed But Center Adjustable
- Working Stage: Double Layer Mechanical Stage, Size 132\*140mm
- Highlight: 18mm eyepiece opto edu microscope, backward nosepiece opto edu microscope, opto edu microscope laboratory equipment



### More Images

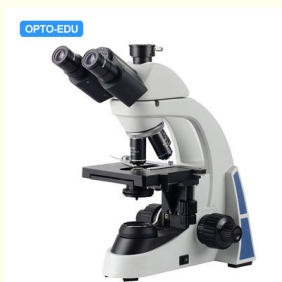

## Product Description

Monocular & Binocular & Trinocular, WF10x/18, Quadruple, Achromatic 4x10x40x100x, Double Layer Mechanical Stage, Size 132\*140mm,3W LED

A12.0909 Biological Microscope		A	B	C	A1	B1	C1
Head	Monocular Head, 30° Inclined,	●			●		
	Binocular Head, 30° Inclined, Diopter Adjustable +/-5°, Interpupillary Distance 50~75mm		●			●	
	Trinocular Head, 30° Inclined, Diopter Adjustable +/-5°, Interpupillary Distance 50~75mm, Light Split Ratio 80:20			●			●
Objective	Achromatic 4x,10x,40x(S),100x(O,S)	●	●	●			
	Plan 4x,10x,40x(S),100x(O,S)				●	●	●
Eyepiece	WF10x/18mm						
Nosepiece	Backward, Quadruple Nosepiece						
Working Stage	Double Layer Mechanical Stage, Size 132*140mm, Moving Range 50*76mm, Precision 0.1mm						
Condenser	Abbe N.A.1.25, With Iris Diaphragm, Fixed But Center adjustable						
Focusing	Low Position Designed, Coaxial Coarse & Fine Focusing, Coarse Focusing Range 25mm, Fine Focusing Scale 0.002mm, With Tension Adjustment, With Upper Safety Stop						
Light Source	3W LED High Brightness						
Power	External Wide Voltage AC Adapter, 100V-240V_AC50/60Hz Input, DC6V 2A Output.						
	External Wide Voltage AC Adapter, 100V-240V_AC50/60Hz Input, DC7.5V 2A Output. (Optional)						
	Internal Switch 100V-240V_AC50/60Hz (Optional)						
	Internal 4 Pieces Rechargeable Batteries, External Wide Voltage Battery Charger, 100V-240V_AC50/60Hz Input, DC6V 1A Output. (Optional)						
A12.0909 Biological Microscope Optional Accessories							
Eyepiece	PL10x/18mm with Pointer, High-Eyepoint	E51.0906-1018P					
	PL10x/18mm with Reticle, High Eyepoint	E51.0905-1018PR					
Adapter	C-Mount 1.0x	A55.0926-10					
	C-Mount 0.35x	A55.0926-35					
	C-Mount 0.50x	A55.0926-50					
	C-Mount 0.67x	A55.0926-67					



## A12.0909 Biological Microscope



## Product Details



A12.0909-A/A1



A12.0909-B/B1



A12.0909-C/C1

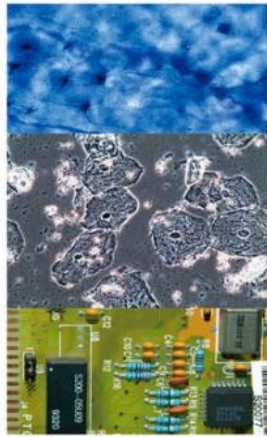

A12.0909 biological microscope with elaborate appearance and reliable quality, is beautiful and practical. Its easy operation and clear image inspire students' imagination and interesting of microscopy world, is helpful to explore the mystery of life science. New generation of scientists are born from here.



**Compact And Solid, Innovative Frame**  
 The frame with hollow design is light weight but stable, easy to carry.

**LED Illumination System, Multiple Power Supplies For Option**  
 Built-in Rechargeable Batteries For Option, 8 Hours Continuous Working Is Available. Common Illumination Systems Adopt 100v-240v AC50/60hz Wide Voltage, External Or Internal For Option.

External Wide Voltage AC Adapter, 100V-240V, AC50/60Hz Input, DC6V 2A Output.



Plan Objectives: 4x, 10x, 40x, 100x

**A33.0909 3.5" LCD Digital Microscope,**  
 Consist of:  
 --A12.0909 Biological Microscope  
 --A59.0920 3.5" LCD Digital Camera

**Binocular Head Interpupillary Distance Adjustable 50~75mm**



Item	Magnification	N.A. (mm)	WD (mm)	Cover Glass (mm)	Parfocal Distance (mm)	Conjugate Distance (mm)
Achromatic Objective	4x	0.10	21.30	0.17	45	195
	10x	0.25	6.40			
	40xs	0.65	0.48			
	100xs (Oil)	1.25	0.15			
Item	Magnification	N.A. (mm)	WD (mm)	Cover Glass (mm)	Parfocal Distance (mm)	Conjugate Distance (mm)
Plan Achromatic Objective	4x	0.10	15.10	0.17	45.00	195.00
	10x	0.25	1.50			
	20x	0.40	8.70			
	40xs	0.65	0.38			
	100xs (Oil)	1.25	0.09			

### Product Diagram

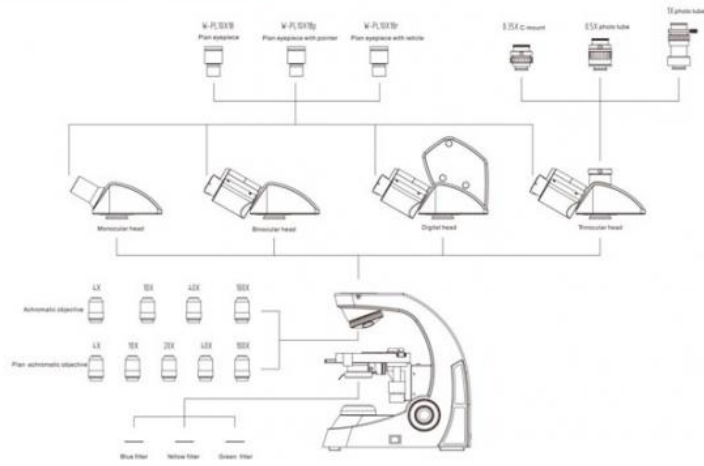



Product Size (mm)

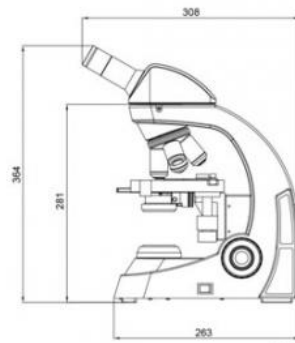

A12.0909-A/A1

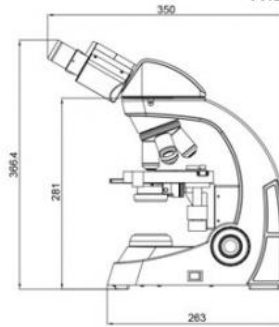
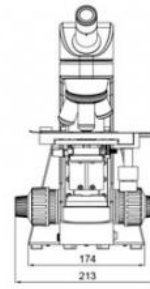

A12.0909-B/B1

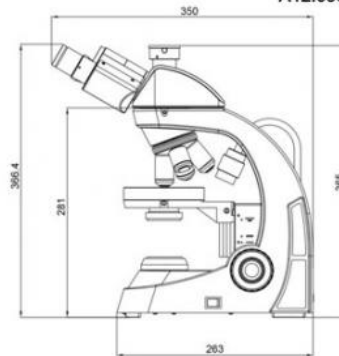
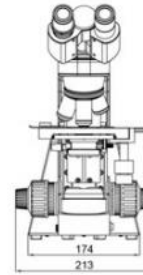

A12.0909-C/C1

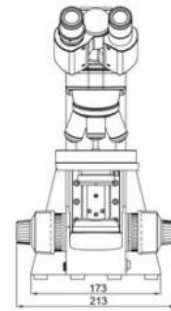

Opto-Edu (Beijing) Co., Ltd.

☎ 0086 13911110627

✉ sale@optoedu.com

🌐 cnoec.com

F-1501 Wanda Plaza, No. 18 Shijingshan Road, Beijing 100043, China