



OPTO-EDU A16.2601 40x - 1000x LED Trinocular Fluorescence Microscope For Research / Learning

Our Product Introduction

Basic Information

- Place of Origin: China
- Brand Name: CNOEC, OPTO-EDU
- Certification: CE, Rohs
- Model Number: A16.2601
- Minimum Order Quantity: 1 pc
- Price: FOB \$1~1000, Depend on Order Quantity
- Packaging Details: Carton Packing, For Export Transportation
- Delivery Time: 5~20 Days
- Payment Terms: T/T, West Union, Paypal
- Supply Ability: 5000 pcs/ Month



Product Specification

- Application: Research|Learning
- Certification: CE|Rohs
- Drawtube: Binocular|trinocular
- Illumination: LED
- Magnification: 40x - 1000x
- Theory: Fluorescence Microscope
- Highlight: **digital trinocular microscope,
usb digital microscope**



for more products please visit us on cnoec.com



OPTO-EDU (BEIJING) CO., LTD.

F-1501 Wanda Plaza, No.18 Shijingshan Road, Beijing 100043, China
Tel:+8610 88696020 Fax:+8610 88696085

A16.2601-L LED Fluorescent Microscope





**Seidentopf Head Inclined 30°
Rotatable 360° , Interpupillary Distance 48-75mm**

Seidentopf Head

Inclined 30°, Rotatable 360°, Interpupillary Distance 48-75mm, High Eyepoint Eyepiece, Which Is Convenient For People With Different Sitting Height;

The Integrated Design Of The Eyepiece Lens Barrel, Avoids The Loss And Contamination Of The Eyepiece And Enhances The Integrated Performance Of The Microscope



Exclusive And Innovative Low-power Dimming Objective

Quadruple, Backward

4 Sets Objective Available: Achromatic, Plan, Infinity E-Plan, Infinity Plan.



Mechanical Stage Size 145 × 140mm
Travel Range 76 × 52mm

Double Slide Holder Working Stage

Mechanical Stage Size: 145 mm×140mm, Travel: 76mmX52mm, Scale: 0.1mm



Abbe Condenser N.A.1.25, Iris Diaphragm, Rack & Pinion Up/Down



3W-LED Illumination Systems

Condenser & Light Source

Abbe Condenser N.A.1.25, Iris Diaphragm, Rack & Pinion Up/Down, With Filter Holder
3W-LED Illumination Systems



Coaxial Coarse & Fine Focusing



Holding Hole On Back



Wire Winding Device



Powered By Safety Low Voltage Charger, Input Wide Voltage 100V-240V, Output 5V1A, Support Power Bank Supply For Outdoor Use



6 Holes Disk Fluorescence Unit

6 Holes Disk Fluorescence Unit

Can Load Up to 5 Fluorescence Filters + 1 Hole For Bright Field View,



5W LED Lamp House

5W LED Lamp Fluorescent

Illumination Unit, With Field Diaphragm, Light Switch Lever.

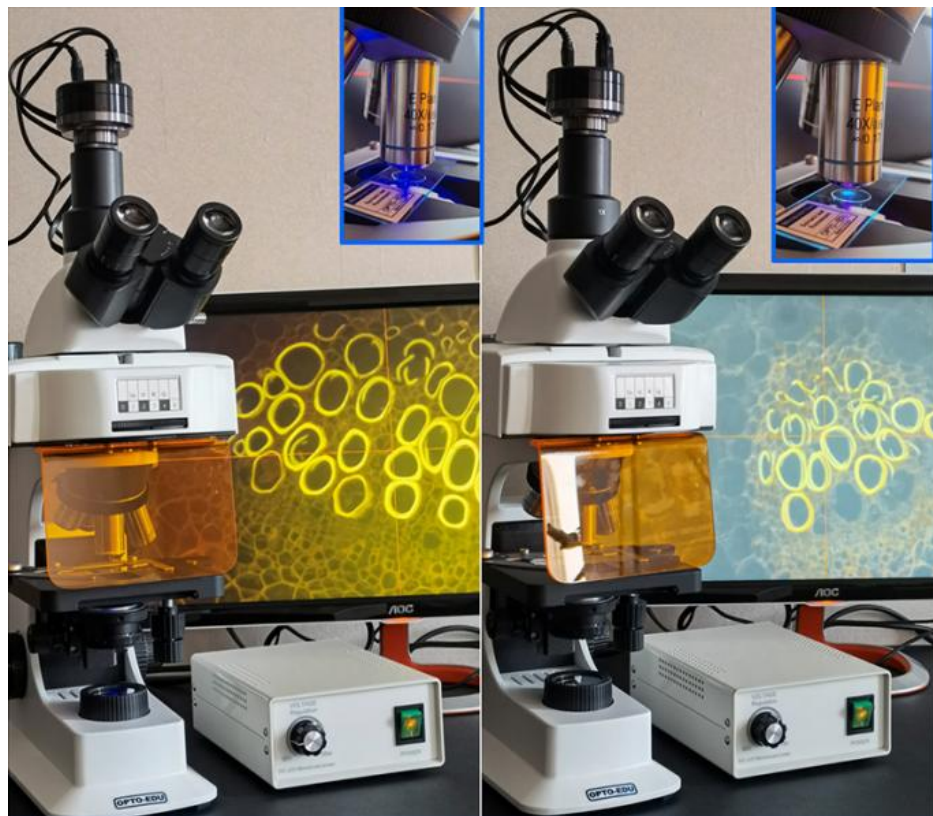

B & U Spinach Leaf Fluorescent Effect



G & UV Spinach Leaf Fluorescent Effect

Items	A16.2601-L LED Fluorescent Microscope Specification	-B2	-T2	-B4	-T4	Cata. No.
Head	Seidentopf Binocular Head Inclined 30°,Rotatable 360°, Interpupillary Distance 48-75mm	●		●		A53.2621-B
	Seidentopf Trinocular Head Inclined 30°,Rotatable 360°, Interpupillary Distance 48-75mm, Light Split Fixed P20:E80		●		●	A53.2621-T
Eyepiece	WF10X/20mm (High Eyepoint)	●●	●●	●●	●●	A51.2602-1020
Nosepiece	Quadruple, Backward	●	●	●	●	A54.2610-N734
	Quintuple, Backward	○	○	○	○	A54.2610-N735
Infinity E-Plan Objective	EPLAN 4x/0.10,W.D.=12.1mm	●	●	●	●	A52.2605-4
	EPLAN 10x/0.25,W.D.=4.14mm	●	●	●	●	A52.2605-10
	EPLAN 40x/0.65(S),W.D.=0.58mm	●	●	●	●	A52.2605-40
	EPLAN 100x/1.25(S, Oil),W.D.=0.19mm	●	●	●	●	A52.2605-100
Infinity Plan Semi-APO Fluorescent Objective	UplanFLN 4x, N.A.0.16,W.D.=17.151mm	○	○	○	○	A5F.2611-4
	UplanFLN 10x, N.A.0.30,W.D.=7.68mm	○	○	○	○	A5F.2611-10
	UplanFLN 20x, N.A.0.50,W.D.=1.96mm	○	○	○	○	A5F.2611-20
	UplanFLN 40x, N.A.0.75,W.D.=0.78mm	○	○	○	○	A5F.2611-40
	UplanFLN 100x(Oil), N.A.1.30,W.D.=0.15mm	○	○	○	○	A5F.2611-100
Working Stage	Mechanical Stage Size: 145 mm×140mm, Travel: 76mm×52mm, Scale: 0.1mm, Double Slide Holder	●	●	●	●	A54.2601-S04
	Rackless (Integrated) Stage, Size 140×135mm, Travel Range 75×35mm, Double Slide Holder	○	○	○	○	A54.2601-S12
Focusing	Coaxial Coarse & Fine Focusing, Coarse Focusing Travel Range: 26mm, Fine Focusing Travel Range: 2μm/Division	●	●	●	●	
Condenser	Abbe Condenser N.A.1.25, Iris Diaphragm, Rack & Pinion Up/Down	●	●	●	●	A56.2614-C06b
Illumination	3W-LED Illumination Systems Powered By Safety Low Voltage Charger, Input Wide Voltage 100V-240V, Output 5V1A, Support Power Bank Supply For Outdoor Use	●	●	●	●	A56.2613-3W
	12V/20W Halogen Lamp	○	○	○	○	A56.2650-20W
	6V/30W Halogen Lamp	○	○	○	○	A56.2650-30W
Field Diaphragm	Upgrade To Kohler Illumination	○	○	○	○	A56.2615-S
Filter	Dia.45mm, Blue	○	○	○	○	A56.2616-45B
	Dia.45mm, Green	○	○	○	○	A56.2616-45G
	Dia.45mm, Yellow	○	○	○	○	A56.2616-45A
Dark Field	Dark Field Condenser, Dry, N.A.0.83-0.91, For 4x10x40x Objective	○	○	○	○	A5D.2610-S
Polarizing	Analyzer + Polarizer Set	○	○	○	○	A5P.2601-S
	Infinity Plan Phase Contrast Objective 10x + Phase Contrast Slide 10x + Phase Contrast Condenser + Telescope 11x + Green Filter	○	○	○	○	A5C.2601-10

Phase Contrast	Infinity Plan Phase Contrast Objective 20x + Phase Contrast Slide 20x + Phase Contrast Condenser + Telescope 11x + Green Filter	○	○	○	○	A5C.2601-20
	Infinity Plan Phase Contrast Objective 40x + Phase Contrast Slide 40x + Phase Contrast Condenser + Telescope 11x + Green Filter	○	○	○	○	A5C.2601-40
	Infinity Plan Phase Contrast Objective 100x + Phase Contrast Slide 100x + Phase Contrast Condenser + Telescope 11x + Green Filter	○	○	○	○	A5C.2601-100
	Turret Phase Contrast Attachment Infinity Plan Phase Contrast Objective 10x20x40x100x, Turret Phase Contrast Condenser 5-Holes, Telescope 11x, Green Filter	○	○	○	○	A5C.2603-S
Fluorescence	Upgrade From A12.2601-C/CT Biological Microscope With: B,G China Fluorescent Set 6 Holes Disc Fluorescent Unit 5W LED Lamp House 5W LED Power Box Ultraviolet Protection Barrier	●	●			A5F.2602-2
	Upgrade From A12.2601-C/CT Biological Microscope With: B,G,U,UV China Fluorescent Set 6 Holes Disc Fluorescent Unit 5W LED Lamp House 5W LED Power Box Ultraviolet Protection Barrier			●	●	A5F.2602-4
Adapter	C-Mount 0.5x, Focus Adjustable	○	○	○	○	A55.2601-05
	C-Mount 0.75x, Focus Adjustable	○	○	○	○	A55.2601-75
	C-Mount 1.0x, Focus Adjustable	○	○	○	○	A55.2601-10
	Upgrade From A12.2601-C/CT Fluorescence Microscope With:	○	○	○	○	A55.2610
Mirror	Reflecting Mirror & Holder	○	○	○	○	A56.2601
Attachment	Wire Winding Device	○	○	○	○	A50.2602-S
Package	Carton Size 970×340×440mm, 1 pc / Ctn					
Weight	Gross Weight: 22 kgs, Net Weight: 18 kgs					

Note: "●" In Table Is Standard outfits, "○" Is Optional Accessories

Fluorescent Filters

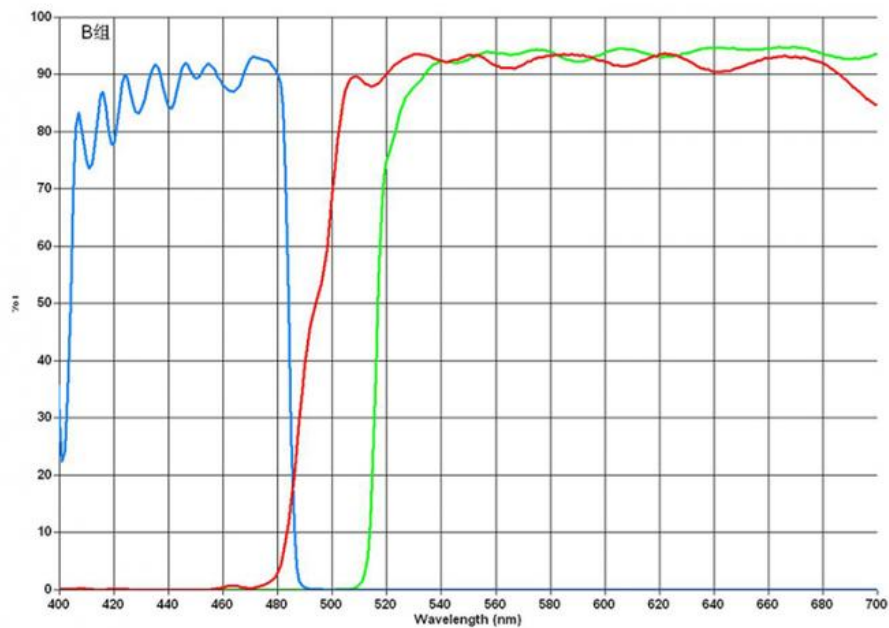

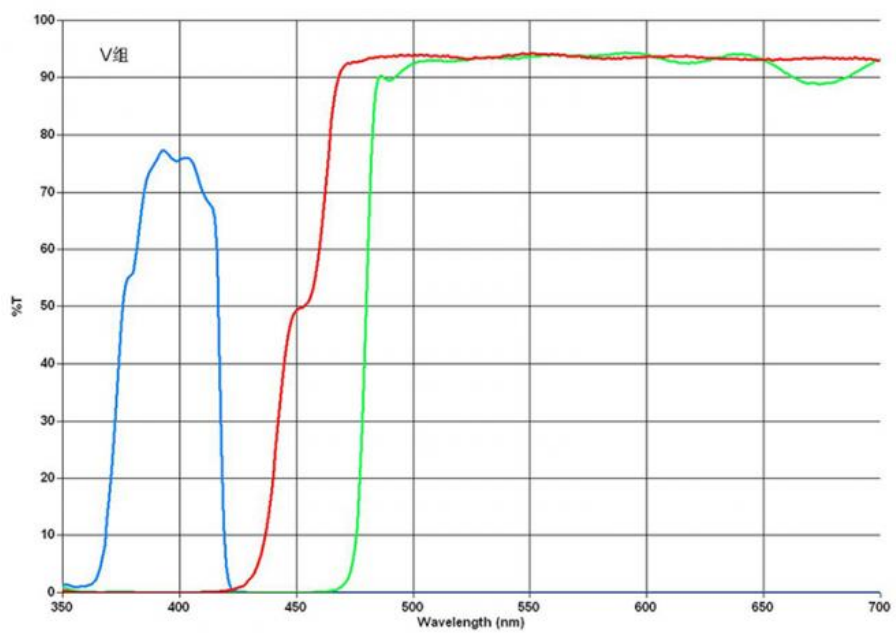
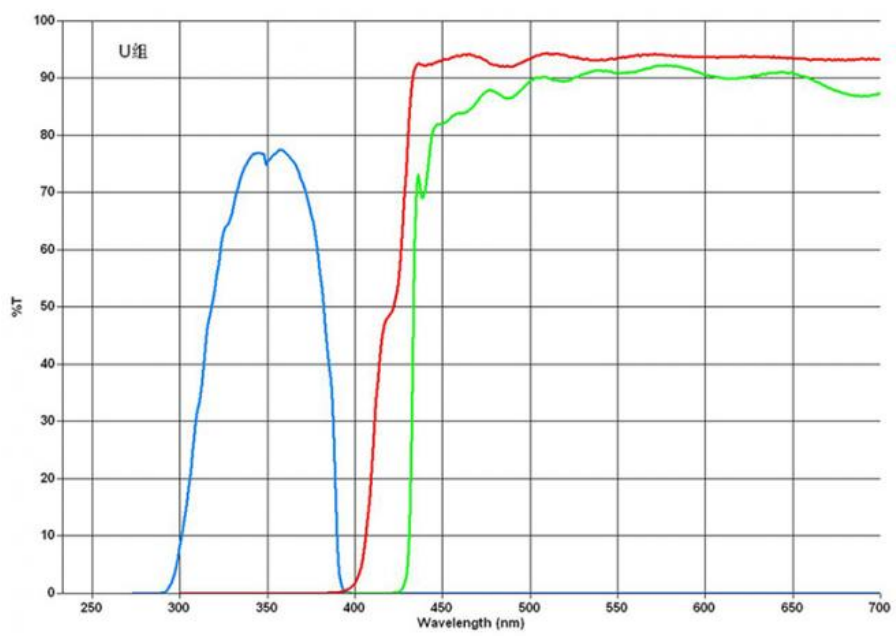
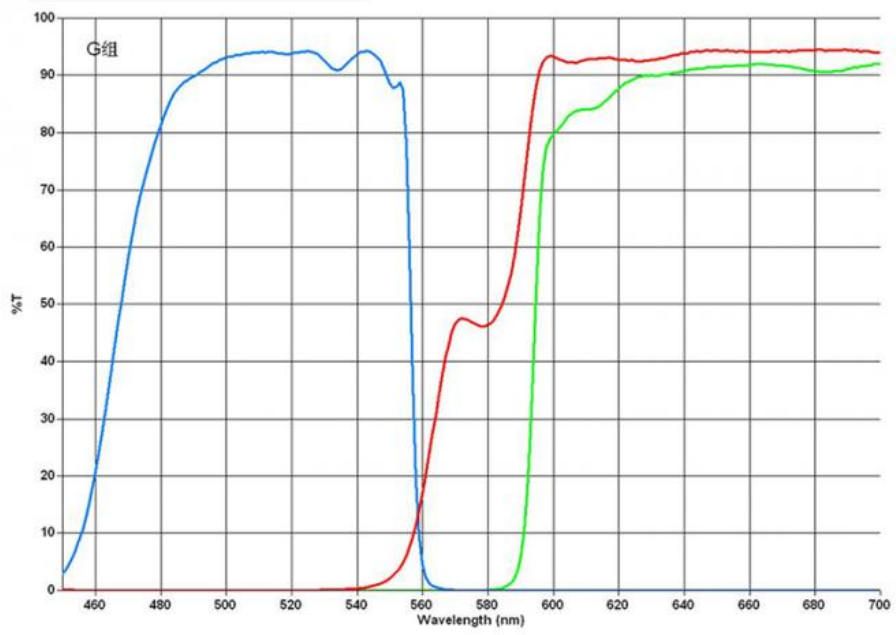

Fluorescent Filters	Exciter (nm)	Dichroic (nm)	Emitter (nm)
UV	330-380	400	435
V	380-420	430	460
B	420-490	505	520
G	500-550	575	590

Product Accessories



A5C.2601

Phase Contrast Objective + Side + Condenser + Telescope + Green Filter



A5C.2603-S

Turret Phase Contrast Attachment



A5P.2601-S
Analyzer + Polarizer Set

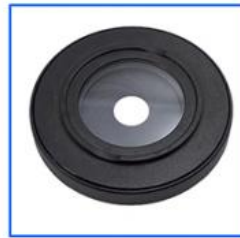

A56.2615-S
Field Diaphragm



A55.2601-10
C-Mount 1.0x,
Focus Adjustable



A56.2601
Reflecting Mirror & Holder



A55.2601-75
C-Mount 0.75x,
Focus Adjustable



A54.2601-S12
Rackless (Integrated) Stage



A5D.2610-S
Dark Field Condenser, Dry



A55.2601-05
C-Mount 0.5x,
Focus Adjustable



A5F.2611
Infinity Plan Semi-APO Fluorescent Objective



A55.2610
Digital Eyepiece
Camera Adapter



A56.2616
Filter : Blue, Green, Yellow

Product Size(mm)

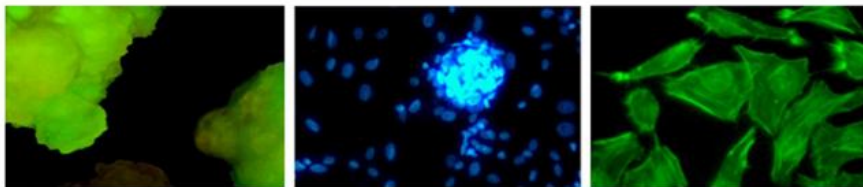
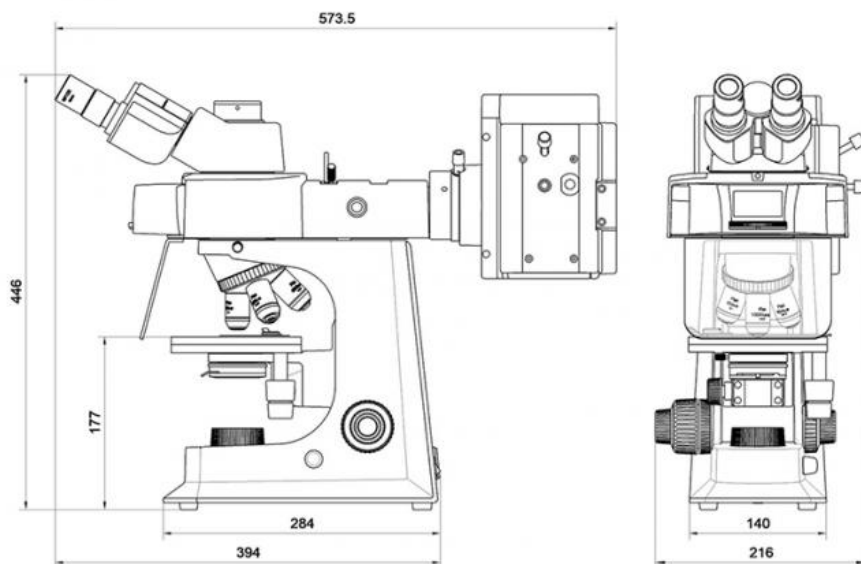

Opto-Edu (Beijing) Co., Ltd.

☎ 0086 13911110627

✉ sale@optoedu.com

🌐 cnoec.com

F-1501 Wanda Plaza, No. 18 Shijingshan Road, Beijing 100043, China