



Laboratory Fluorescence Microscope

Our Product Introduction

for more products please visit us on cnoec.com

Basic Information

- Place of Origin: China
- Brand Name: CNOEC, OPTO-EDU
- Certification: CE, Rohs
- Model Number: A16.0901
- Minimum Order Quantity: 1 pc
- Price: Negotiation
- Packaging Details: Carton Packing, For Export Transportation
- Delivery Time: 5~20 Days
- Payment Terms: T/T, West Union, Paypal
- Supply Ability: 5000 pcs/ Month



Product Specification

- Application: Research, Laboratory
- Certification: CE, Rohs
- Drawtube: Trinocular
- Illumination: Halogen Lamp
- Magnification: 100x - 400x
- Theory: Fluorescence Microscope
- Highlight: **epi-fluorescence microscope, inverted fluorescence microscope**



More Images

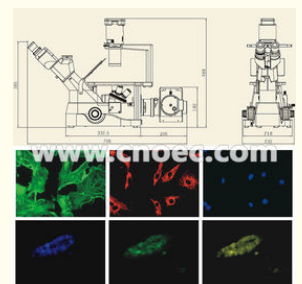

Product Description

Description:

A16.0901 Laboratory Inverted Fluorescence Microscope, Critical Illumination, designed for cell culture observation, to get details of cell growing process, internal spontaneous fluorescence phenomenon, living cell fluorescence transfection, protein transfer and etc.

--New generation of infinity color corrected optical system, professional plan semi-apochromatic fluorescence objectives, present you sharp and bright fluorescence image.

--Professional fluorescence filter system, imported optical material and broadband multilayer coating, high transmissivity, mould proof, heat insulation and safety protection system, OSRAM brand mercury lam digital power supply control.

--Swallow tail slide switch easy to change filter cubes, three paths for fluorescence and one for bright field, four filter cubes can be mounted.

--Scientific research class cold CCD, high resolution, fast transmission. Intelligence Chinese fluorescence image processing software, meets and request of the most professional picture processing.

--6V30W transmission illuminator, various performances, bright field, dark field, phase contrast, polarization observations.

Specifications:

	A16.0901	A16.0901-CCD
Optical System	Infinity Color Corrected Optical System	
Head	Trinocular Head , Gemel Viewing Head, 45 Degree Inclined, Interpupillary Distance 54-75mm, Splitting Ratio 100:0 or 0:100	
Eyepiece	PL10x/22mm, High Eyepoint, Wide Field	
Nosepiece	Revolving Quintuple Nosepiece	
Objective	Long Working Distance Infinity Plan Achromatic Objectives LWDPL10X/0.25, W.D.=7.94mm LWDPL20X/0.40, W.D.=7.66mm LWDPL40X/0.60, W.D.=3.71mm Long Working Distance Infinity Plan Phase Contrast Objectives LWDPH20X/0.40, W.D.=7.66mm	Long Working Distance Infinity Plan Fluorescent Objectives LWDPLF4X/0.13, W.D.=18.52mm LWDPLF10X/0.30, W.D.=7.11mm Long Working Distance Infinity Plan Semi-Apochromatic Objectives LWDPLFPH20X/0.45, W.D.=5.91mm LWDPLFPH40X/0.65, W.D.=1.61mm Long Working Distance Infinity Plan Phase Contrast Objectives LWDPH10X/0.25, W.D.=7.94mm
Stage	Fixed Stage Size 250*160mm, Slider Clips --Glass Plate --Metal Plate --Petri Dish Holder, Dia.35mm . . .	Fixed Stage Size: 250*160mm, Slider Clips, with Extension Plate and Coaxial Moveable Stage, Moving Range120*78mm --Glass Plate --Metal Plate with Kidney Slot --Petri Dish Holder, Dia.35mm --Slide Holder, Dia.54mm,26.5x76.4mm --Teraseki Holder, Dia.65mm,56x81.5mm
Focusing	Coaxial Coarse & Fine Focusing System, Coarse Adjustment Range 9mm, Fine Adjustment Precision 0.002mm,with Tension Adjustment, with Safty Stop	
Condenser	N.A.0.3 Kohler Illumination Condenser, with Phase Adjustable Slide Plate, Long Working Distance 72mm. The Whole Set Can Be Rotated Down	
Phase Contrast	Phase Contrast Plug-board for 10x-40x, Center Adjustable Centering Telescope Dia. 30mm	
Filter	Dia.45mm Green Interference Filter Dia.45mm Color Temperature Change Filter Attenuation Plate, Transmission 25%	
Reflected Fluorescence illumination System	--Reflected Kohler Illumination with Iris Field Diaphragm, Centering Adjustable --U-LH100HG Mercury Lamp House, Filament Center and Focal Distance Adjustable, with Mirror, Mirror Center and Focal Distance Adjustable --U1-RFLT100 Digital Power Control Box, Wide Voltage Range 90-240V AC --Imported OSRAM 100W DC Mercury Bulb Centered Objective For Mercury Bulb Band-pass Fluorescent Filter B, G Band-pass Fluorescent Filter B, G, UV 30ND25 Attenuation Plate	
CCD Adapter	0.67x CCD Adapter, for 2/3" CCD Camera	
CCD Camera		1.4M, 2/3" CCD, USB 2.0 Cold CCD Scientific Research Class Cold CCD,
Light	Critical Illumination, With Iris Aperture, Halogen 6V30W, Pre-centered, Intensity Adjustable	
Power	Wide Voltage 90-240V	



Attachable Mechanical Stage
Moving Range 120*78mm. It Can Clamp Types Of
Standard Cell Culture Plates. With The Help Of Related
Accessories. It Could Be Used to Move The Dish, Flask,
Slides And So On.



www.cnoec.com

High Performance Fluorescence Filter

Have a high transmittance of the spectrum, also have good depth and steepness of the cutoff line. Without a cross color but a high S/N ratio, fluorescence imaging contrast was promoted dramatically. We Choose Stray light elimination of the background to the filter blocks. The background of the image becomes darker, and the fluorescence brighter.



New Designed High Eye-point Wide Field Plan Eyepiece PL10x22mm, Has Full Bright Diagram Without Chromatic Circle. Wide Filed of Viewing 22mm Is Convenient For Target Seeking And Counting



OLIP Series Long Working Distance Infinity Color Corrected Objectives, Designed For Living Cells Culture In Laboratory, Clear Image, Good Contrast And Nice For Fluorescence Observation



Semi-Apochromatic Fluorescence Objectives
New generation professional infinity plan semi-apochromatic fluorescence lens with high numerical aperture 25% higher



Phase Contrast Slides Used With Phase Contrast Objectives, Can Get A Better Image Than Bright Field, The Cell Image Is With A Strong Sense Of Relief.



www.cnoec.com

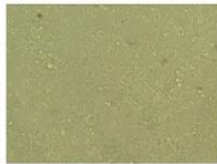

←
Observation of Living Cell
 GFP-Transfected 293T cell culture, observed under 3 different ways:
 -Bright Field
 -Phase Contrast
 -Fluorescence

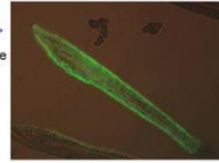
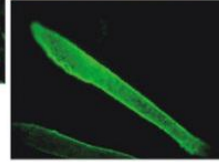
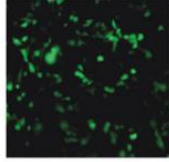

→
Observation in Vivo
 Amphioxus larvae, observe the development of the larvae under 3 different ways:
 -Phase Contrast
 -Auto-Fluorescence
 -Combine 2 images to analyze the distribution of proteins in the larvae.

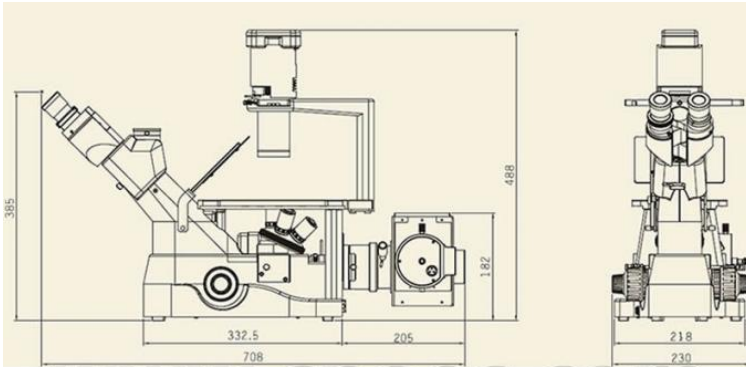

www.cnoec.com

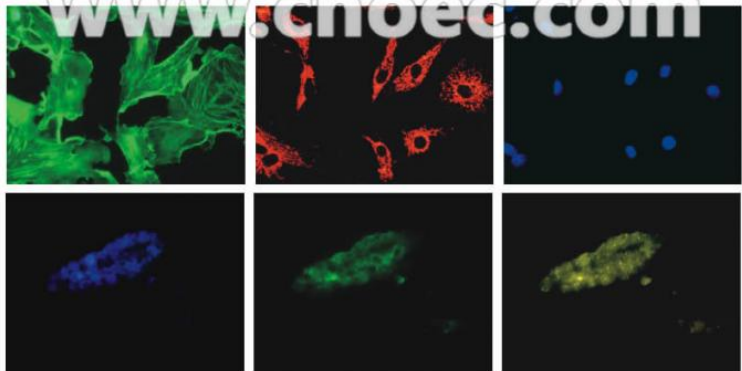

Opto-Edu (Beijing) Co., Ltd.

☎ 0086 13911110627

✉ sale@optoedu.com

🌐 cnoec.com

F-1501 Wanda Plaza, No. 18 Shijingshan Road, Beijing 100043, China