



Infinity Laboratory Biological Microscope LED Illumination With CE A12.0205

Our Product Introduction

Basic Information

- Place of Origin: China
- Brand Name: CNOEC
- Certification: CE
- Model Number: A12.0205
- Minimum Order Quantity: 1
- Price: Negotiation
- Packaging Details: Carton
- Delivery Time: 1 month
- Payment Terms: T/T, West Union and Paypal
- Supply Ability: 10000



Product Specification

- Highlight: **high powered microscope , biological compound microscope**



for more products please visit us on cnoec.com

More Images

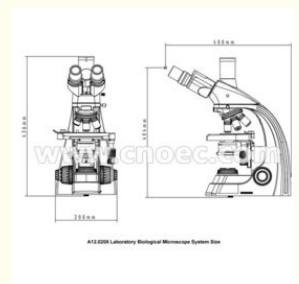
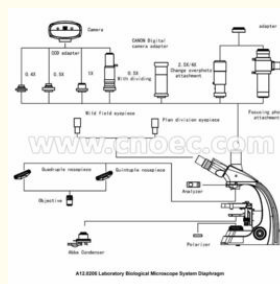

Product Description

Infinity Laboratory Biological Microscope LED Illumination With CE A12.0205

A12.0205 Laboratory Biological Microscope, Newly Designed in 2012, equipped with infinity plan achromatic objectives and wide field eyepieces. It have beautiful sculpt and provide clear image, wide field, convenience operation. It can be used for biology medicine agriculture and industry area widely. It is the ideal instrument in medical treatment, teaching demonstration and scientific research.

- High Quality Infinity Optcal System
- 360° Rotatable Head Adaptor For Easy Viewing Height Adjustable
- Backward Quadruple Nosepiece, Ball Bearing Inner Locating
- Infinity Plan Achromatic Objective 4x,10x,20x,40x,60x,100x Available
- Newly Designed Rackless Mechanical Stage Avoid Hurt Operator's Hand
- Dark Field, Polarizing, Phase Contrast Attachment Optional

A12.0205 Laboratory Biological Microscope		
Optical System	Infinity Optical System	
Head	Trinocular Head, 30° Inclined, Interpupillary Distance 55~75mm, Both Eyepiece Tube Diopter Adjustable +/-5°, 100% Light Pass To Photo Tube 360° Rotatable Head Adaptor For Easy Viewing Height Adjustable	
Eyepiece	WF10x/22mm Wide Field Eyepiece	
Nosepiece	Backward Quadruple Nosepiece, Ball Bearing Inner Locating	
Objective	Infinity Plan Achromatic Objective: PL4x/0.10, W.D.21mm PL10x/0.25, W.D. 5.0mm PL40x/0.65, W.D. 0.66mm, Spring PL100x/1.25, W.D.0.36mm, Spring, Oil	
Working Stage	Rackless Double Layer Mechanical Stage 180*150mm, Moving Range 75*50mm	
Focusing	Coaxial Coarse & Fine Focus Knob, With Tension Adjustable And Limit Stopper, Minimum Division 0.002mm	
Condenser	Abbe Condenser N.A.1.25, Rack & Pinion Height Adjustable	
Filter	Blue Filter, Ground Glass	
Light Source	High Light LED, Brightness Adjustable	
A12.0205 Laboratory Biological Microscope Optional Accessories		
Eyepiece	Retical Eyepiece, WF10x/22mm, Micrometer Div 0.1mm	A51.0205-G10B
Objective	Infinity Plan Achromatic Objective PL20x/0.40, W.D.8.8mm	A52.0206-20
	Infinity Plan Achromatic Objective PL60x/0.85, W.D.0.25mm	A52.0206-60
Filter	Green Filter	A56.0209-02
	Yellow Filter	A56.0209-03
Phase Contrast	Centering Telescope	A5C.0212-2
	Infinity Plan Phase Contrast Objective 10x/0.25 PHP	A5C.0234-P10
	Infinity Plan Phase Contrast Objective 20x/0.40 PHP, Spring	A5C.0234-P20
	Infinity Plan Phase Contrast Objective 40x/0.65 PHP, Spring	A5C.0234-P40
	Infinity Plan Phase Contrast Objective 100x/1.25 PHP, Spring, Oil	A5C.0234-P100
	Sliding Phase Contrast Condenser	A5C.0210-12
Polarizing	Simple Polarizing Set Polarizer, 360° Rotatable, Used On Base Light Collector Analyzer Slide, Inserted Into Hole On Nosepiece	A5P.0201-2
Dark Field	Dark Field Condenser, Dry	A5D.0211-D
	Dark Field Condenser, Immersion	A5D.0211-I
Adapter	CCD Adapter 0.4x	A55.0202-01
	CCD Adapter 0.5x	A55.0202-04
	CCD Adapter 1.0x	A55.0202-02
	CCD Adapter 0.5x With Dividing 0.1mm/Divv	A55.0202-03
	Digital SLR Camera Adapter for Canon EF Series	A55.0204-02



www.cnoec.com

A12.0205 Laboratory Biological Microscope



Simple Polarizing Attachment Optional
Polarizer Used On Light Collector Of Base,
Analyzer Inserted Into Hole on Nosepiece



Rackless Working Stage
New Rackless Design Avoid Hurt
Operator's Hand, Large Size 180*150mm,
Moving Range 75*50mm

www.cnoec.com





Back Handle Design
For Easy Carrying The Microscope By One Hand



360° Rotatable Head Adaptor For Easy Viewing Height Adjustable

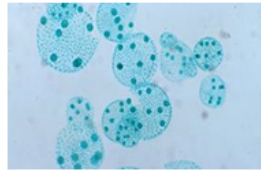
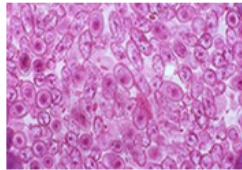

A12.0205 Biological Microscope
Trinocular Head, Both Eyepiece Tube Diopter Adjustable, With WF10x/22mm Wide Field Plan Eyepiece

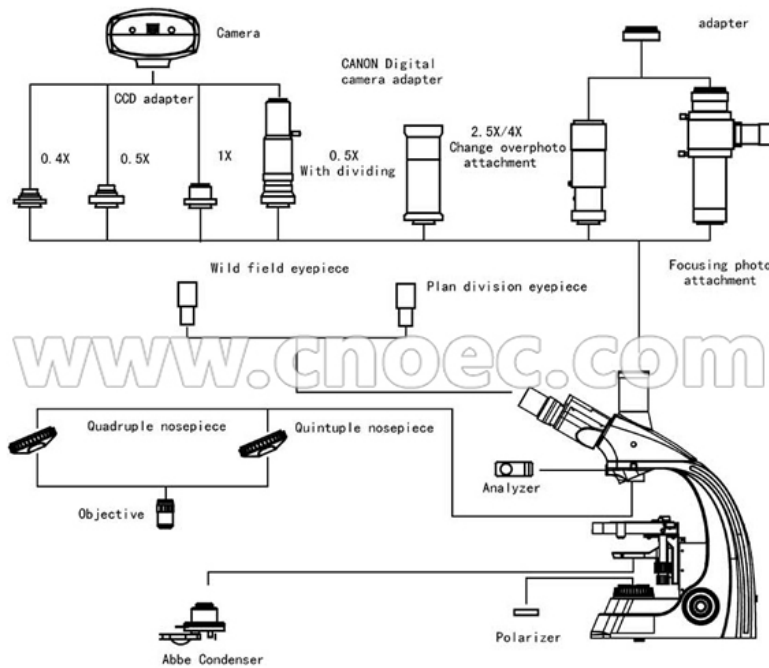

A12.0205 Laboratory Biological Microscope System Diaphragm

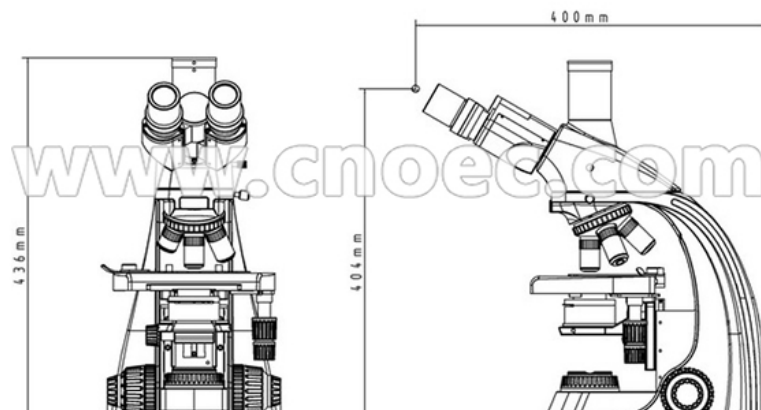



A12.0205 Laboratory Biological Microscope System Size



Opto-Edu (Beijing) Co., Ltd.

 0086 13911110627

 sale@optoedu.com

 cnoec.com

F-1501 Wanda Plaza, No. 18 Shijingshan Road, Beijing 100043, China