



OPTO-EDU A12.2253 Infinity Trinocular Biological Laboratory Microscope

Our Product Introduction

Basic Information

- Place of Origin: China
- Brand Name: OPTO-EDU
- Certification: CE, Rohs
- Model Number: A12.2253
- Minimum Order Quantity: 1 pc
- Price: FOB \$1~1000, Depend on Order Quantity
- Packaging Details: Carton Packing, For Export Transportation
- Delivery Time: 5~20 Days
- Payment Terms: T/T, West Union, Paypal
- Supply Ability: 5000 pcs/ Month



Product Specification

- Head: Trinocular
- Eyepiece: WF10X/23
- Nosepiece: 6 Holes Manual Operating Nosepiece
- Objective: Achromatic 4x10x20x40x100x
- Working Stage: Manual Operating Working Stage Nano Anti-Wear Ceramic Coating Surface Right Hand XY Moving Knob With Damping Adjustment Ring
- Focusing: Focusing Range: 27mm Coaxial Coarse And Fine Focusing System With Safety Stop Lock Ring & Tension Adjustable
- Condenser: Abbe Condenser N.A=1.1
- Illumination: Built-in Transmit Kohler Illumination, LED
- Highlight: **A12.2243 Biological Laboratory Microscope, OPTO-EDU Biological Laboratory Microscope, Infinity Trinocular Biological Laboratory Microscope**

for more products please visit us on cnoec.com



OPTO-EDU (BEIJING) CO., LTD.

F-1501 Wanda Plaza, No.18 Shijingshan Road, Beijing 100043, China
Tel:+8610 88696020 E-mail:sale@cnoec.com

A12.2253, A13.2253, A16.2253

Laboratory Microscope, Trinocular, Coded Quintuple,
Infinity Plan High N.A.4X,10X,20X,40X,100X Objectives



A13.2253
Metallurgical Microscope



A12.2253
Laboratory
Biological Microscope



A16.2253
Fluorescent Microscope



▶ **Trinocular Head**

Trinocular Ultra Wide Filed, 30 °Inclined,
Rotatable Upright Image,
Light Split: (E0/P100, E50/P50),
And Another Version: (E0/P100, E50/P50, E100/P0)

► **Diopter Adjustable Eyepiece**

Interpupillary:50mm-80mm, Diopter Adjustable -2~+8°With Eyecup, There are three specifications Of Filed Number (FN = 23mm, FN = 25mm, FN = 26.5mm), Dia.30mm.



► **Nosepiece**

6 Holes Coded Manual Operating Nosepiece, RMS

► **Working Stage**

Manual Operating Stage,3"X2",Nano Anti-wear Ceramic Coating Stage, Right-handed XY Coaxial Adjustment with Damping Adjustment Ring

► **Achromatic Objective**

Infinity Plan Achromatic Objective 4x, 10x, 20x, 40x, 100x



► **Condenser**

Abbe Condenser,N.A=1.1,4X~100X

► **Light Source**

SUPERMELEDTM Large Power Wide Color Gamut LED Light House,60000 Hours,4500K Color Temperature

► **Button Control Magnification Switching**

By touching the button on the body, the magnification of the objective can be switched easily, avoiding pollution, wear, and looseness caused by long-term contact with the objective lens.





► Metallurgical Illuminator

EPI Reflect Illumination, with BF & DF Module, With Polarizing Slot

► Fluorescent Illuminator

Turret Epi-Fluorescent Illumination, 4 Holes, Build-In UV, Blue, Green Excitation Module, With Polarizing Slot



A12.2253, A13.2253, A16.2253 Optional

OPTO-EDU



High-Precision Electric Platform

The electric platform (stepper motor) adopts the same connection and installation method as the ordinary manual stage. With only one bolt, the manual stage can be upgraded and replaced with an electric XY stage. The long X-axis travel can load 1-4 standard slides at same time. It comes with integrated control software, which can centrally operate and control all electronic components of the microscope.

Encoded Electric Z-axis Accessories

The encoded electric Z-axis accessories are composed of a dual-axis stepper motor and a multi-turn encoder, with a minimum step size of 0.8 degrees (360 degrees with 200 subdivisions). The encoder can provide real-time feedback of Z-axis coordinate data. The installation is simple and does not require any damage to the body structure. Only 2 screws are needed to complete the installation, and the structure is firm.



Multifunctional computer drive

It can achieve driving control of components such as the electric objective turntable (R), electric stage (XY), electric Z-axis (Z), camera external trigger, etc. It can communicate with the computer through RS232 and USB ports to achieve software control and programmed action processing.

Electric microscope joystick controller

Equipped with full control over the electric loading platform (XY), electric Z-axis (Z), and electric objective turntable (R), with high, medium, and low speed three speed switches. Change to precise control of XYZ, support up to 6 objective lenses for arbitrary switching, and need to be used in conjunction with M-DRV 200 multifunctional computer driver.



A12.2253, A13.2253, A16.2253 Details

OPTO-EDU

► Illumination System

Lumi Cite Ultra-High Brightness, SUPERMLED High-Power And Wide Color Gamut LED Light, 60,000 Hours, 4500K Color Temperature, Sunlight Simulated

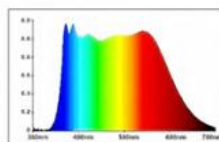
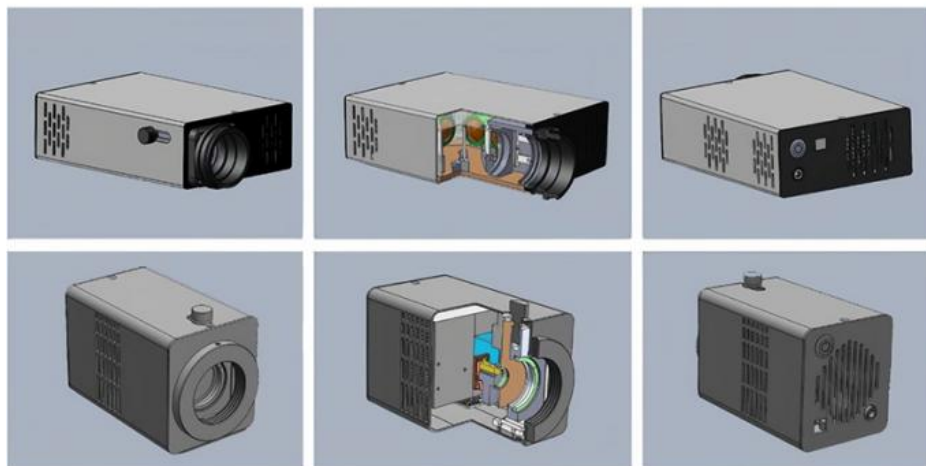

High Power and Wide Spectral
White LED Light Source



Ultra High Power and Wide Spectral
White LED Light Source

A12.2253, A13.2253, A16.2253 Features

OPTO-EDU



Tool-free disassembly and assembly of reflective filter blocks.

The user pulls out the well and removes the casing in the horizontal direction, turns the turntable to the hole position that needs to be operated, gently pulls out the filter block or pushes it inward with the thumb and forefinger, covers the casing, and removes/installs it to complete.

Lens anti-mildew treatment

All optical lenses are made of environmentally friendly lead-free glass material, and the surface is treated with a special anti-mold coating, making them more durable in laboratory environments.

Excellent Optical Properties

The new ECGO infinite bidirectional chromatic aberration calibration system objective lens with a new optical architecture has three zoom distance designs of 45mm, 60mm, and 95mm, which can balance high resolution and long working distance, as well as special biology-specific 40x and 100x coverslip-free objective lenses, making it easier for users to capture microscopic structures of bacteria and chromosomes more clearly during coverslip-free sample detection.

Maintenance-free long-life light source

Transmission lighting uses SUPERMLEDIM large-scale LED light-emitting array packaged with multi-core stack technology, simulating solar light sources. The emission spectrum is uniform and continuous in the visible light range of 400nm to 650nm, with a constant temperature of 4500K. It has high-fidelity color reproduction ability for various stained specimens, especially for colors that are difficult to distinguish under ordinary LED lights such as cyan, purple, and pink, and has super strong color rendering ability.

Antibacterial coating

Microorganisms and viruses can be transmitted through contact, so we have treated all contact points with antibacterial additives to create a healthy laboratory environment.

Automatic light intensity management function:

By operating the LIMVSET key and dimming, different objective lenses can be independently set for brightness in advance, so that the brightness can always be maintained in the best state regardless of the magnification switch in daily use.

USB output to computer control

Through the USB data port at the back of the fuselage, it can be directly connected to the computer, and various electronic components of the microscope can be controlled through software, including cameras, stage objective lens turntables, bright field transmission light sources, fluorescent light sources, electric diaphragms, and electric polarizers.

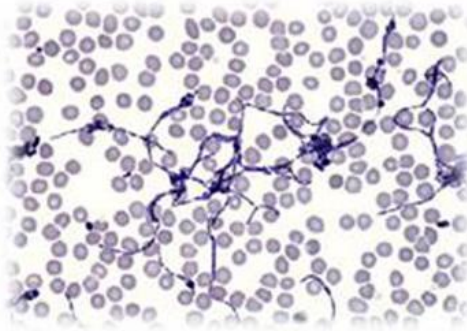
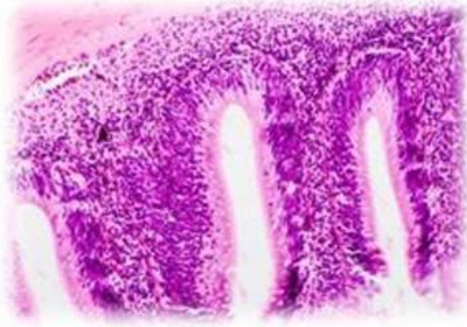

Tissue slice observation does not require cumbersome operations and complex settings

No special settings are required, and the factory mode can achieve perfect observation of tissue sections stained with conventional H. E staining; the specially designed simulated full-spectrum SUPERLED™ high-power light source combined with the Kohler lighting system can easily obtain clear images with equal brightness, high contrast, and soft color temperature from 4x to 100x observation, and can easily distinguish stained colors such as blue, purple, and pink that are difficult to restore with high fidelity under ordinary microscopes

High-contrast objective lenses for observing blood cells, chromosomes, and microorganisms

The new ECGO infinite bidirectional chromatic aberration calibration system objective lens with a new optical architecture has three zoom distance designs of 45mm, 60mm, and 95mm, which can balance high resolution and long working distance, as well as special biology-specific 40x and 100x coverslip-free objective lenses, making it easier for users to capture microscopic structures of bacteria and chromosomes more clearly during coverslip-free sample detection.

A tool for observing details of animal and plant packaging - dark field condenser

High-quality equal-path dark-field condenser provides more perfect dark-field illumination while suppressing the chromatic aberration of the objective lens, making the image edges of the observed sample sharp and clear, not only ensuring uniform background, but also ensuring uniform brightness throughout the field of view

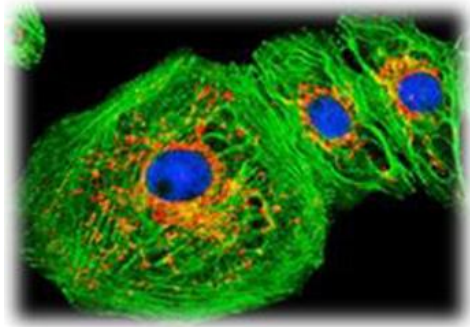

Easy acquisition of high signal-to-noise ratio fluorescent images

Using a traditional fluorescence microscope to take high-quality fluorescence images takes up a long time for users: the background is not black enough, the signal is not strong enough, the details are unclear, and the quenching speed is too fast... Moreover, we use OD6 high transmittance IBS hard coating filter, self-developed ultra-high-power LumiCite series solid-state fluorescence dedicated light source, fluorite material high transmittance high-resolution fluorescence objective lens, electronic shutter, software programmed exposure control, making fluorescence shooting no longer difficult, and work efficiency has improved by leaps and bounds.

Observation of polymer materials, starch, crystals, cosmetics, and traditional Chinese medicine - polarizing

For the above applications, high-performance polarizing accessories are essential. We use a seventh-generation thin polarizer with a higher extinction ratio and no change in color temperature to improve the orthogonal background contrast. The standard 45mm polarizer can be placed at the light source outlet, and the 30mm polarizer can be placed in the DIC slot of the objective lens turntable. It is extremely convenient to push in and pull out, and there is no need to increase the cost of purchasing additional slot accessories.

A12.2253, A13.2253, A16.2253 Specification **OPTO-EDU**



A12.2253



A16.2253



A13.2253

Item.	A12.2253 Laboratory Biological Microscope Series	A12.2253 Biological	A16.2253 Fluorescent	A13.2253 Metallurgical	Model. No
Optical System	ECGO Infinity Plan Mutual Achromatic Optical System, Confocal: 45mm	BF,DF,PH,POL	BF,FL	BF/DF,POL,DIC	

Main Body	S53F Main Body, --Coaxial Coarse & Fine Focusing, With Safety Stop Lock Ring & Tension Adjust Ring, Focusing Range 27mm, Coarse Stroke 17.6mm, Fine Stroke 0.1mm, Fine Scale 1µm --Built-in Transmit Kohler Illumination, Light Intensity Management (LIM) System, Brightness Memory Function, ECO Auto-Off Function, One Key Switch Reflect / Transmit Light	●	●	●	A54.2201-S53F
	Focusing Transmit Light --USB Port Connect Computer, Support Software Auto Switch Measuring Scale & Camera Parameter For Each Objectives --Main Body Supply Power Supply For Both Transmit & Reflect Light				
	S53F2 Full Motorized Main Body --USB Port Connect Computer, Computer Can Fully Control Microscope Motorized "XYZRLCC": X/Y/Z Stage Moving, Nosepiece, Light, Condenser, Capture Photo & Video	○	○	○	A54.2201-S53F2
	A12.2253 Arm For Installing Nosepiece, Fixed To Main Body By 4 Screws	●	●	●	A54.2201-SA
Head & Video Adapter	Trinocular Head, Light Split (0/100, 50/50), FN=23mm	●	●	●	A53.2201-ST01
	Trinocular Head, Light Split (0/100, 50/50, 100/0), Ultra Wide FN=26.5	○	○	○	A53.2201-ST02
	1.0x C-Mount + Focus Adapter Ring, For Sensor 2/3"~4/3", Used With ST01, ST02	○	○	●	A55.2201-1xC
	0.63x C-Mount, For Sensor 1/1.8"~ 2/3", Used With ST01, ST02	○	○	○	A55.2201-63xC
	0.5x C-Mount, For Sensor 1/2"~ 1/1.8", Used With ST01, ST02	○	○	○	A55.2201-05xC
	Erect Image Trinocular Head, Light Split (0/100, 50/50), Ultra Wide FN=26.5	○	○	○	A53.2201-ST03
	0.63x C-Mount, For Sensor 1/1.8"~ 2/3", Used With ST03	○	○	○	A55.2201-63xB
	Erect Image Trinocular Head, Light Split (50/50), Ultra Wide FN=26.5, Tiltable 0-45°	○	○	○	A53.2201-ST04
	1.0x C-Mount, For Sensor 2/3"~4/3", Used With ST04	○	○	○	A55.2201-1xA
0.63x C-Mount, For Sensor 1/1.8"~ 2/3", Used With ST04	○	○	○	A55.2201-63xA	
Eyepiece	Ultra Wide Field 10x/23mm, Diopter Adjustable -2~+8°, With Eyecup	●	●	●	A51.2201-1023
	Ultra Wide Field 10x/25mm, Diopter Adjustable -2~+8°, With Eyecup	○	○	○	A51.2201-1025
	Ultra Wide Field 10x/26.5mm, Diopter Adjustable -2~+8°, With Eyecup	○	○	○	A51.2201-1026.5
Nosepiece	6 Holes Coded Manual Nosepiece, M20.32 Screw (RMS)	●	●	/	A54.2202-S6
	6 Holes Motorized Nosepiece, M20.32 Screw (RMS)	○	○	/	A54.2203-6
	5 Holes Manual Nosepiece, M26 Screw, For BF/DF, Center Adjustable	/	/	●	A54.2202-UP5BD
	5 Holes Motorized Nosepiece, M26 Screw, For BF/DF	/	/	○	A54.2203-5BD
	5 Holes Motorized Nosepiece, M26 Screw, Center Adjustable	/	/	○	A54.2203-5CA
Objective	PLCN Infinity Plan Achromatic Objective, Cover Glass- 0.17				A51.2202
	4X, N.A=0.10, W.D=17mm, OFN=23	○	○	/	A51.2202-4
	10X, N.A=0.25, W.D=10mm, OFN=23	○	○	/	A51.2202-10
	20X, N.A=0.40, W.D=3mm, OFN=23	○	○	/	A51.2202-20
	40X, N.A=0.65, W.D=0.6mm, OFN=23	○	○	/	A51.2202-40
	60X, N.A=0.80, W.D=3mm, OFN=23	○	○	/	A51.2202-60
	100X, N.A=1.25, W.D=0.25mm, OFN=23	○	○	/	A51.2202-100
	UPLN Infinity Plan Achromatic Objective, Cover Glass- 0.17				A51.2203
	4X, N.A=0.13, W.D=17mm, OFN=26.5	●	○	/	A51.2203-4
	10X, N.A=0.30, W.D=10mm, OFN=26.5	●	○	/	A51.2203-10
	20X, N.A=0.50, W.D=3mm, OFN=26.5	●	○	/	A51.2203-20
	40X, N.A=0.75, W.D=0.6mm, OFN=26.5	●	○	/	A51.2203-40
	100X, N.A=1.3, W.D=0.25mm, OFN=26.5	●	○	/	A51.2203-100
Objective	UPLFLN Infinity Plan Semi-APO FL Objective, Cover Glass- 0.17				A5F.2201
	4X, N.A=0.15, W.D=12mm, OFN=26.5	○	●	/	A5F.2211-4

Fluorescent Objective	10X, N.A=0.30, W.D=9mm, OFN=26.5	○	●	/	A5F.2211-10
	20X, N.A=0.65, W.D=2.3mm, OFN=26.5	○	●	/	A5F.2211-20
	40X, N.A=0.9, W.D=0.7mm, OFN=26.5	○	●	/	A5F.2211-40
	100X, N.A=1.3, W.D=0.3mm, OFN=26.5	○	●	/	A5F.2211-100
Metallurgical BF Objective	MPLFLN Infinity Plan Semi-Apo EPI BF Objective				A5M.2211
	5X, N.A=0.16, W.D=16mm, OFN=26.5	/	/	○	A5M.2211-5
	10X, N.A=0.30, W.D=9mm, OFN=26.5	/	/	○	A5M.2211-10
	20X, N.A=0.45, W.D=3mm, OFN=26.5	/	/	○	A5M.2211-20
	50X, N.A=0.80, W.D=3mm, OFN=26.5	/	/	○	A5M.2211-50
	100X, N.A=0.90, W.D=1.1mm, OFN=26.5	/	/	○	A5M.2211-100
	20X-L, N.A=0.40, W.D=12mm, OFN=26.5	/	/	○	A5M.2211-20L
	50X-L, N.A=0.60, W.D=9.5mm, OFN=26.5	/	/	○	A5M.2211-50L
	100X-L, N.A=0.80, W.D=3mm, OFN=26.5	/	/	○	A5M.2211-100L
	NEOPLAN Infinity Semi-APO FL EPI BF Objective, High Resoluition For Industry Fluorescent Observation				A5M.2212
	2.5X, N.A=0.08, W.D=10mm, OFN=26.5	/	/	○	A5M.2212-2.5
	5X, N.A=0.16, W.D=15mm, OFN=26.5	/	/	○	A5M.2212-5
	10X, N.A=0.30, W.D=15mm, OFN=26.5	/	/	○	A5M.2212-10
	20X, N.A=0.55, W.D=5mm, OFN=26.5	/	/	○	A5M.2212-20
20X-L, N.A=0.50, W.D=9mm, OFN=26.5	/	/	○	A5M.2212-20L	
20X-L, N.A=0.45, W.D=12mm, OFN=26.5	/	/	○	A5M.2212-20SL	
50X, N.A=0.85, W.D=1mm, OFN=26.5	/	/	○	A5M.2212-50	
50X-L, N.A=0.80, W.D=2mm, OFN=26.5	/	/	○	A5M.2212-50L	
50X-L, N.A=0.55, W.D=8.7mm, OFN=26.5	/	/	○	A5M.2212-50SL	
100X-L, N.A=0.80, W.D=3.1mm, OFN=26.5	/	/	○	A5M.2212-100	
Metallurgical BF/DF Objective	MPLFLN Infinity Plan Semi-APO EPI BD Objective				A5M.2215
	5X, N.A=0.16, W.D=16mm, OFN=26.5	/	/	●	A5M.2215-5
	10X, N.A=0.30, W.D=9mm, OFN=26.5	/	/	●	A5M.2215-10
	20X, N.A=0.45, W.D=3mm, OFN=26.5	/	/	○	A5M.2215-20
	50X, N.A=0.80, W.D=3mm, OFN=26.5	/	/	○	A5M.2215-50
	100X, N.A=0.90, W.D=1.1mm, OFN=26.5	/	/	○	A5M.2215-100
	20X-L, N.A=0.40, W.D=12mm, OFN=26.5	/	/	●	A5M.2215-20L
	50X-L, N.A=0.60, W.D=5mm, OFN=26.5	/	/	●	A5M.2215-50L
	100X-L, N.A=0.80, W.D=3mm, OFN=26.5	/	/	●	A5M.2215-100L
	MXAPO Infinity Plan Semi-APO FL EPI BD Objective High Resoluition For Industry Fluorescent Semi-Conductor Observation				A5M.2216
	5X, N.A=0.15, W.D=15mm, OFN=26.5	/	/	○	A5M.2216-5
	10X, N.A=0.30, W.D=14mm, OFN=26.5	/	/	○	A5M.2216-10
	20X, N.A=0.55, W.D=4mm, OFN=26.5	/	/	○	A5M.2216-20
	50X, N.A=0.80, W.D=4mm, OFN=26.5	/	/	○	A5M.2216-50
100X, N.A=0.90, W.D=1mm, OFN=26.5	/	/	○	A5M.2216-100	
20X-L, N.A=0.50, W.D=9mm, OFN=26.5	/	/	○	A5M.2216-20L	
50X-L, N.A=0.85, W.D=1mm, OFN=26.5	/	/	○	A5M.2216-50L	
20X-L, N.A=0.85, W.D=3mm, OFN=26.5	/	/	○	A5M.2216-100L	
LWD Objective	MPLSAPO Infinity Plan APO FL LWD Objective, Confocal 95mm For Large Sample, High Temperature Heating Sample Observation				A5M.2231
	2X, N.A=0.06, W.D=35mm, OFN=26.5	○	○	○	A5M.2231-2
	5X, N.A=0.15, W.D=45mm, OFN=26.5	○	○	○	A5M.2231-5
	10X, N.A=0.30, W.D=35mm, OFN=26.5	○	○	○	A5M.2231-10
	20X, N.A=0.45, W.D=21mm, OFN=26.5	○	○	○	A5M.2231-20
	50X, N.A=0.75, W.D=12mm, OFN=26.5	○	○	○	A5M.2231-50
	100X, N.A=0.80, W.D=6mm, OFN=26.5	○	○	○	A5M.2231-100
	20X-L, N.A=0.3, W.D=31mm, OFN=26.5	○	○	○	A5M.2231-20L
	50X-L, N.A=0.55, W.D=22mm, OFN=26.5	○	○	○	A5M.2231-50L
	Adapter to Raise Height 40mm For A5M.2231 APO 95mm Objectives	○	○	○	A5M.2231-HA
Working Stage	Manual Working Stage 3"x2", 255x160mm, Moving 55x75mm, Ultra Hard Nano Wear-resistant Ceramic Coating, With Damping Adjust Ring (Same As Olympus)	●	●	●	A54.2204-O32
	Manual Working Stage 4"x4", Ultra Hard Nano Wear-resistant Ceramic Coating, With Damping Adjust Ring (Same As Olympus)	○	○	○	A54.2204-O44
	Double Slide Holder, For Left Hand Use	●	●	/	A54.2204-SH

	Metal Sample Holder, 3"x2", With Metal Plate For Reflect Light	/	/	●	A54.2204-M32
	Metal Sample Holder, 3"x3", With Glass Plate For Reflect & Transmit Light	/	/	○	A54.2204-M33
	Metal Sample Holder, 4"x4", With Glass Plate For Reflect & Transmit Light	/	/	○	A54.2204-M44
Condenser	Abbe Condenser, N.A=1.1, 4x~100x	●	●	●	A56.2201-11
	Achromatic Aplanatic Condenser, N.A=1.4, 10x~100x	○	○	/	A56.2201-14
	Swing-out Condenser N.A=0.9, 1.25x~100x (1.25x~4x When Swing Out)	○	○	/	A56.2201-S
Transmit Illumination	SUPERLED 10W LED Light House, Life Time 60000 Hours, Wide Color Gamut 4500K Color Temperature	●	●	●	A56.2204-1
	SUPERLED 18W LED Light House, Life Time 60000 Hours, Wide Color Gamut 4500K Color Temperature	○	○	○	A56.2204-2
Reflect Fluorescent Illumination	Epi Fluorescent Turret Illuminator, With 4 Position, With Polarizing Slot	/	●	/	A5F.2201
	Lumi Cite 9100 Solid LED Extra Large Power Illuminator, Preset 4 Wavelengths of Excitation, Wavelength 340~750nm, 80W , Support DAPI, FITC, TRITC, TxRed, Cy5	/	○	/	A5F.2201-L91
	Solid LED Light Source Dimmer For Lumi Cite 9100	/	○	/	A5F.2201-LC91
	Lumi Cite 9300 Solid LED Extra Large Power Illuminator, Preset 4 Wavelengths of Excitation, Wavelength 330~750nm, 130W , Support DAPI, FITC, TRITC, TxRed, Cy5	/	●	/	A5F.2201-L93
	Solid LED Light Source Dimmer For Lumi Cite 9300		●		A5F.2201-LC93
	USB 2.0 Cable Length 2m, Connect Illuminator to Controller or Computer	/	●	/	A50.2202-3
	Chinese Standard Power Adapter 220V/12V/120W DC, For Solid LED Illuminator	/	●	/	A50.2203-5
	Solid LED Light Source Optical Adapter	/	●	/	A5F.2201-OLY
	UV Long Pass Exciter: BP340-390, Emitter: BA420IF, Dichroic: DM410	/	●	/	A5F.2210-UVL
	B Long Pass Exciter BP460-495, Emitter: BA510IF, Dichroic: DM505	/	●	/	A5F.2210-BL
G Long Pass Exciter: BP530-550, Emitter: BA575I, Dichroic: DM570	/	●	/	A5F.2210-GL	
Reflect Metallurgical Illumination	Epi Metallurgical Reflect Illuminator, With BF & DF Module, With Polarizing Slot	/	/	●	A5M.2201-SC
	5W LED Light House For Reflect Illuminator, Life Time 60000 Hours, 4500K Color Temperature	/	/	●	A5M.2201-LH1
Dark Field	Dark Field Condenser (Dry), N.A=0.92, 10x~100x	○	○	/	A5D.2201-D
	Dark Field Condenser (Oil), N.A=1.4, 10x~100x	○	○	/	A5D.2201-I
Phase Contrast	Universal Turret Phase Contrast Condenser, Support BF, DF, PH1, PH2, PH3	○	○	/	A5C.2201
	Green Filter For Phase Contrast Dia.45mm	○	○	/	A5C.2201-G45
	UPLFLN Infinity Plan Semi-APO FL Phase Contrast Objective			/	
	4x, N.A=0.15, CG=0.17, W.D=12mm, OFN=26.5	○	○	/	A5C.2212-4
	10x, N.A=0.30, CG=0.17, W.D=9mm, OFN=26.5	○	○	/	A5C.2212-10
	20x, N.A=0.65, CG=0.17, W.D=2.3mm, OFN=26.5	○	○	/	A5C.2212-20
	40x, N.A=0.90, CG=0.17, W.D=0.7mm, OFN=26.5	○	○	/	A5C.2212-40
100x, N.A=1.30, CG=0.17, W.D=0.3mm, OFN=26.5	○	○	/	A5C.2212-100	
Polarizing	Polarizing Round Working Stage 360° Rotatable With Scale, Center Adjustable, Work With Center Adjustable Nosepiece	○	○	○	A54.2204-R
	Transmit Polarizer Filter Dia.45mm, Put On Transmit Light Port	○	○	○	A5P.2201-P45
	Transmit Analyzer, Insert In Nosepiece Slot	○	○	○	A5P.2201-P30
	Transmit Analyzer Holder	○	○	○	A5P.2201-P45H
	Reflect Polarizer Slide, Insert In Reflect Illuminator Slot.	/	○	○	A5P.2201-A

	Reflect Analyzer Slide, Rotate 360°, Insert In Reflect Illuminator Slot.	/	○	○	A5P.2201-A3
DIC	DIC Slider For Reflect Light	/	/	○	A5C.2210
Camera	3.0M USB 2.0 Camera, Sony 1/2" Color CMOS, Work With 0.5x C-Mount	○	○	○	A59.2271-3M
	6.3M USB 3.0 Camera, Sony 1/1.8" Color CMOS, Work With 0.5x/0.63x C-Mount	○	○	○	A59.2271-6.3M
	20M USB 3.0 Camera, Sony 1" Color CMOS, Work With 1x C-Mount	○	○	○	A59.2271-20M
	8.0M USB 3.0 Fluorescent Camera, Sony 1" Color CMOS, Work With 1x C-Mount	/	○	/	A59.2272-8M
	12.8M USB3.0 Fluorescent Camera, Sony 1" Color CMOS, Work With 1x C-Mount	/	○	/	A59.2272-12.8M
Motorized System	Motorized System, Work With S53F Motorized Body, Need To Order Full Set:				
	Motorize X/Y Stage, Stepper Motor Eliminating Gaps Ball Screw, Moving 118x76mm	○	○	○	A54.2206-30
	4 Slides Holder For Motorized Stage	○	○	○	A54.2206-30SH4
	Motorized Z Axis With Coded System, Directly Install On S53F Body	○	○	○	A54.2207-3
	Quarc Controller, Support PC Control XYZ Motorized Stage + Motorized Nosepiece	○	○	○	A54.2208-M200
	Toton Joystick, Directly Control XYZ Motorized Stage + Motorized Nosepiece	○	○	○	A54.2208-MCP
Other	Immersion Oil 8ml, Reflect Ratio=1.518, Low Viscosity (135CST)	●	●	●	A50.2201-1
	Chinese Standard Power Adapter 220V/24V/36W DC	●	●	●	A50.2203-2
	Dust Cover	●	●	●	A50.2204-1
	Latex Gloves	●	●	●	A50.2204-2
	Hexagonal Tool Kit 3#, 4#	●	●	●	A50.2204-3
	Packing Carton	●	●	●	A50.2204-5



A54.2201-S53F
Manual Main Body



A54.2201-S53F2
Full Motorized Main Body

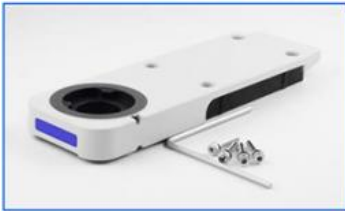

A54.2201-SA



A53.2201-ST01



A53.2201-ST02



A55.2201-1xC



A53.2201-ST03



A53.2201-ST04



A55.2201-1xA



A55.2201-63xA



A55.2201-63xB



A55.2201-63xC



A55.2201-05xC



A51.2201-1023

A51.2201-1025

A51.2201-1026.5

A54.2202-S6

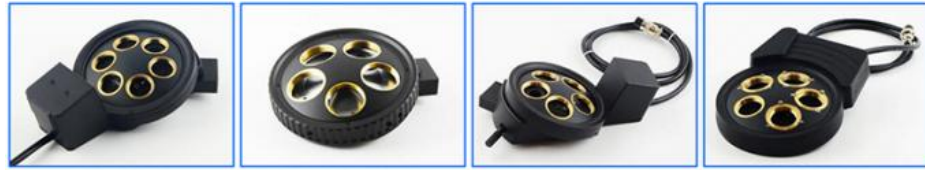

A54.2203-6

A54.2202-UP5BD

A54.2203-5BD

A54.2203-5CA



A51.2202 (PLCN Infinity Plan Achromatic Objective)



A51.2203 (UPLN Infinity Plan Achromatic Objective)



A5F.2211 (Fluorescent Objective: UPLFLN Infinity Plan Semi-APO FL Objective)



A5M.2231 (LWD Objective: MPLSAPO Infinity Plan APO FL LWD Objective)



A5M.2211 (Metallurgical BF Objective: MPLFLN Infinity Plan Semi-Apo EPI BF Objective)



A5M.2212 (Metallurgical BF Objective: NEOPLAN Infinity Semi-APO FL EPI BF Objective)



A5M.2215 (Metallurgical BF/DF Objective: MPLFLN Infinity Plan Semi-APO EPI BD Objective)



A5M.2216 (Metallurgical BF/DF Objective: MXAPO Infinity Plan Semi-APO FL EPI BD Objective)



A5C.2212 (Phase Contrast Objective: UPLFLN Infinity Plan Semi-APO FL Phase Contrast Objective)



A54.2204-O32



A54.2204-O44



A54.2204-SH

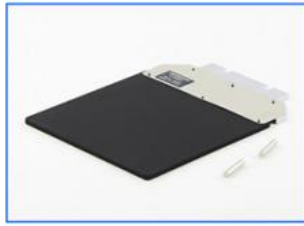

A54.2204-M32



A54.2204-M33



A54.2204-M44



A56.2201-S



A56.2201-11



A56.2201-14



A56.2204-1



A56.2204-2



A5F.2201



A5F.2201-L93



A5F.2201-L91



A5F.2201-LC93



A5F.2201-LC91



A50.2202-3



A50.2203-5



A5F.2201-OLY

A5F.2210-BL

A5F.2210-GL

A5F.2210-UVL



A5M.2201-SC

A5M.2201-LH1

A5D.2201-D

A5D.2201-I

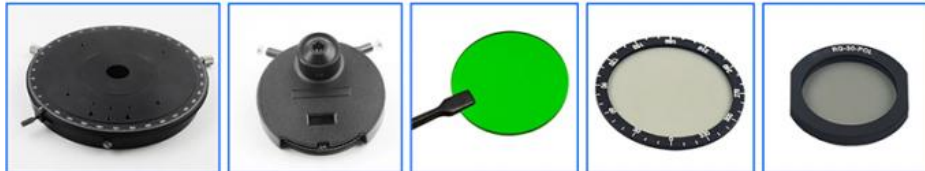

A54.2204-R

A5C.2201

A5C.2201-G45

A5P.2201-P45

A5P.2201-P30



A5M.2231-HA

A5P.2201-A

A5P.2201-A3

A5P.2201-P45H

A5P.2210



A59.2271-3M

A59.2271-6.3M

A59.2271-20M

A59.2272-8M

A59.2272-12.8M



A54.2206-30

A54.2206-30SH4

A54.2207-3

A54.2208-M200

A54.2208-MCP

A12.2253, A13.2253, A16.2253 Dimension



Carton Box: 695mm X 480mm X 435mm
Gross Weight: 30kg

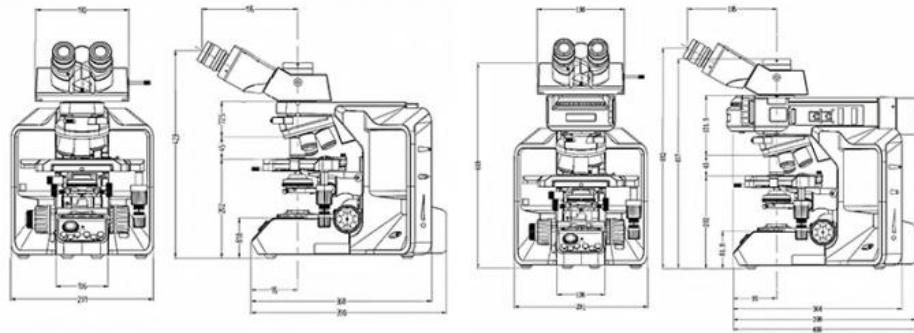
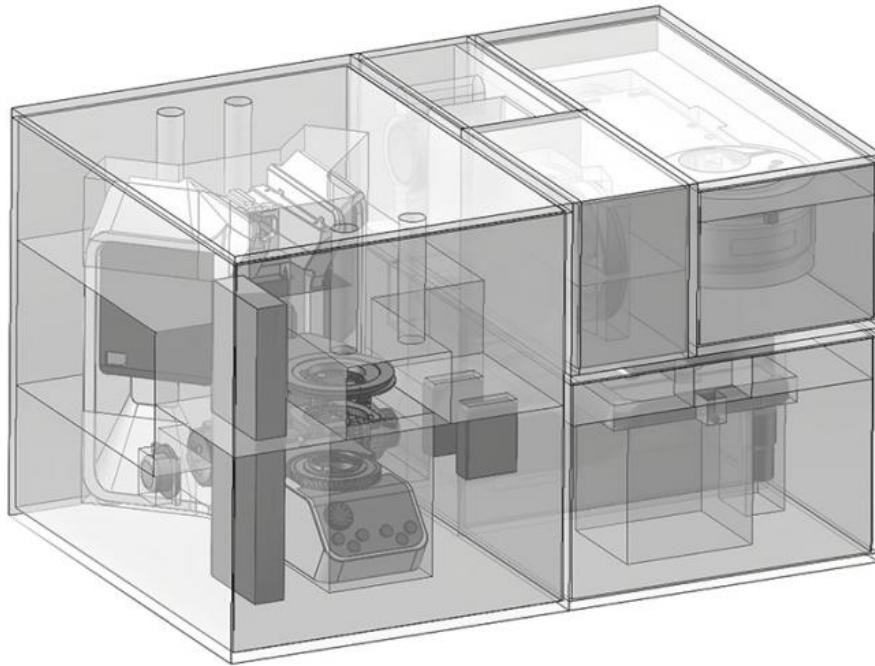

Unit: mm

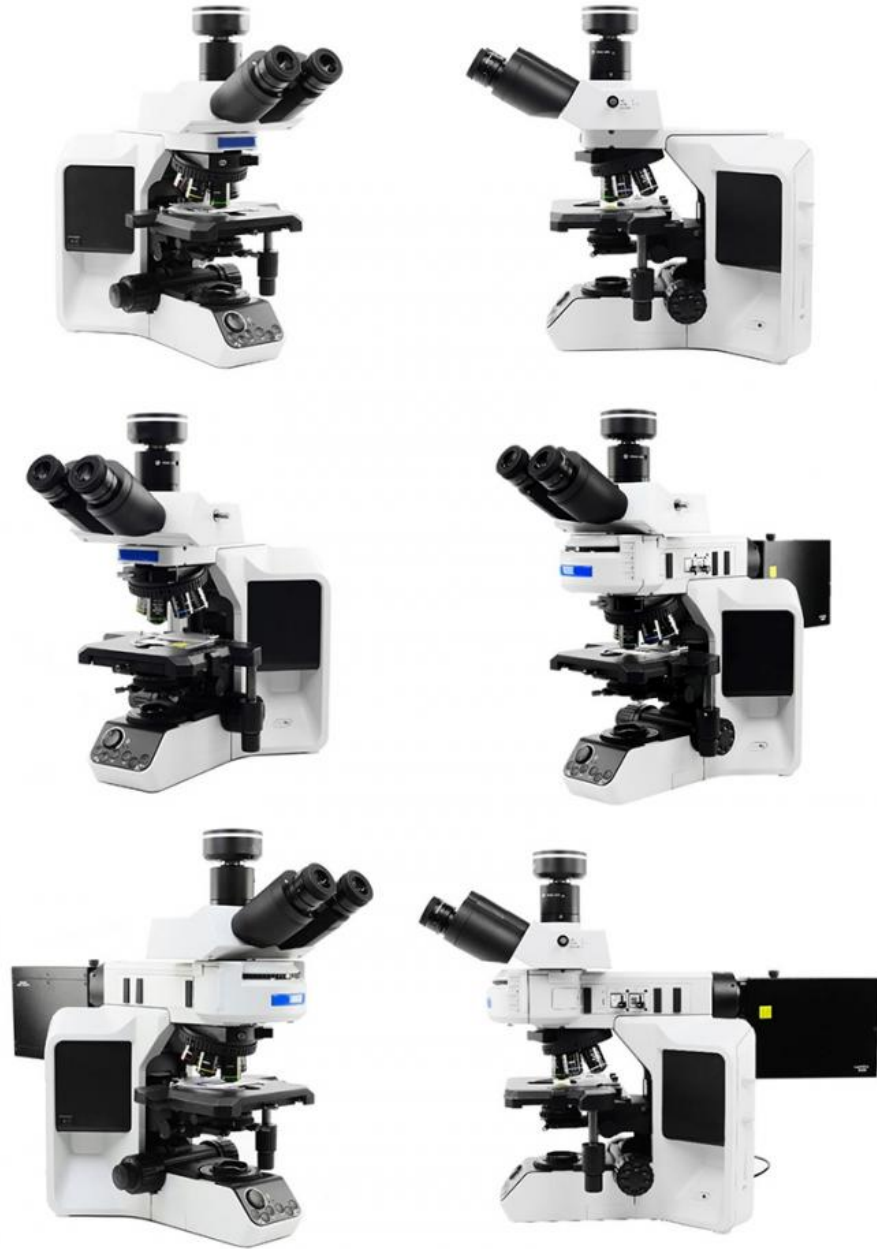

Opto-Edu (Beijing) Co., Ltd.

☎ 0086 13911110627

✉ sale@optoedu.com

🌐 cnoec.com

F-1501 Wanda Plaza, No. 18 Shijingshan Road, Beijing 100043, China