



OPTO EDU A13.1097 Inverted Metallurgical Microscope Coded Nosepiece

Our Product Introduction

Basic Information

- Place of Origin: China
- Brand Name: CNOEC, OPTO-EDU
- Certification: CE, Rohs
- Model Number: A13.1097
- Minimum Order Quantity: 1 pc
- Price: FOB \$1~1000, Depend on Order Quantity
- Packaging Details: Carton Packing, For Export Transportation
- Delivery Time: 5~20 Days
- Payment Terms: T/T, West Union, Paypal
- Supply Ability: 5000 pcs/ Month



Product Specification

- Observation Method: Bright Field
- Head: Seidentopf Trinocular Head, Inclined 45°, Interpupillary Distance 47-78mm
- Eyepiece: SW10x/22mm, High Eyepoint, Diopter Adjustable, Dia.30mm
- Media Lens: Built-in Media Lens Turret, Under Nosepiece, 1.0x, 1.5x Switchable
- Nosepiece: Coded Manual Sextuple Nosepiece, With DIC Slot
- Objective: NIS45 N-MPFN Infinity Plan BF/DF Semi-APO/APO Metallurgical Objective
- Highlight: **Coded Nosepiece Metallurgical Microscope, Inverted Metallurgical Microscope, OPTO EDU Metallurgical Microscope**

for more products please visit us on cnoec.com



A13.1096

Manual

Inverted Metallurgical Microscope, Semi-APO, BF/DF/PL/FL/DIC

A13.1097

Semi-Motorized

Inverted Metallurgical Microscope, Semi-APO, BF/DF/PL/FL/DIC

A13.1098

Full Motorized

Inverted Metallurgical Microscope, Semi-APO, BF/DF/PL/FL/DIC





A13.1097
Semi-Motorized
Inverted Metallurgical Microscope,
Semi-APO, BF/DF/PL/FL/DIC



A13.1098
Full Motorized
Inverted Metallurgical Microscope, Semi-
APO, BF/DF/PL/FL/DIC



Motorized Mechanical Stage

Three-layer mechanical mobile platform, the size of the platform: 340X230mm, the moving range is 130X85mm, and the maximum load-bearing capacity is 30kg. The spacious working space is suitable for placing large and heavy samples. The surface of the stage is scratch-resistant, suitable for observation of various materials and shapes. At the same time, it is equipped with a variety of stage pallets and gaskets. The gaskets of different shapes and apertures can meet the observation and analysis of various smaller samples. The flexible low-hand position handle combines the accuracy and comfort of sample movement observation.



A5M.1091 Infinity Plan Semi-APO/APO BF/DF Metallurgical Objectives

Carefully selected high-transmittance glass and advanced coating technology, accurate color reproduction is ensured. At the same time, for various detection needs, there are a variety of objective lenses to choose from, including high-resolution, polarized light and ultra-long working distance objectives.



Multi-Channel Optical Export, Camera Interface

The optical path outlets are set on the microscope head and the left and right sides, which are used to connect the camera and various application expansion accessories. Through the beam splitter, the splitting ratio of different optical paths is realized, and the conversion is quick and convenient. At the same time, 0.5X, 0.4X and 1X C type interface and different Cameras with specifications to meet different imaging needs.



Intermediate Magnification Switch

Through the intermediate magnification switching dial, the fast switching between 1x and 1.5x can be realized, Make the sample details clearer and the results more credible.

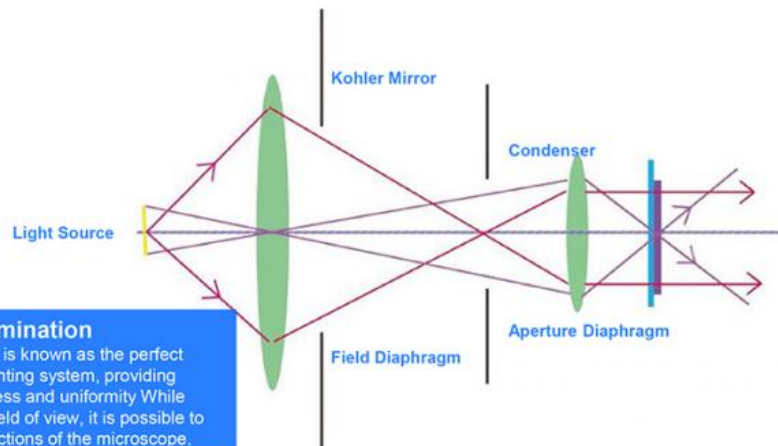

Kohler Illumination
 Kohler Lighting is known as the perfect microscopic lighting system, providing perfect brightness and uniformity. While unfirming the field of view, it is possible to expand the functions of the microscope.



Six Position Multi-Function Turret

It adopts a six-station turntable structure, which can be easily taken out from the host, and it is convenient to place various observation modules. When in use, the observation mode can be changed by just turning the dial, the positioning is accurate, and the use is convenient.



Various Slider to Obtain Clear Images

The field of view adjustment diaphragm and the aperture adjustment diaphragm can be used to adjust the size of the field of view and the sharpness of imaging, as well as adjust the aberration to a certain extent. The filter diaphragm can easily adjust the brightness or color of the light. The analyzer slider can adjust the imaging during polarized observation and DIC. Multiple sliders are used in combination to ensure high-quality microscopic imaging.



45°Tilt Observation Head

Whether sitting or standing, users can observe in a natural posture to reduce fatigue. At the same time, the pupil distance of the observation head is adjustable, and the diopter is adjustable. Meet the usage habits of different operators

Low-hand design

The focusing mechanism, platform moving handle and brightness adjustment adopt low-hand design, so that the user can operate the microscope in the most comfortable posture.

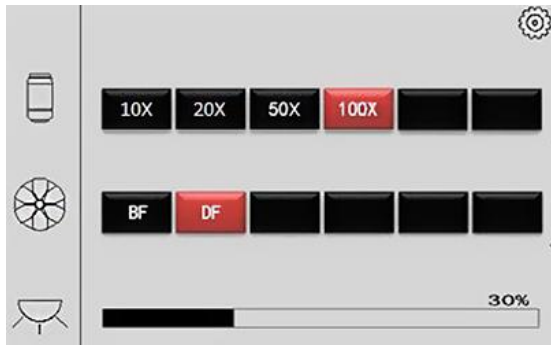

Microscopic Status Display (For A13.1097)

- Converter magnification screen display
- Multi functional turntable band screen display
- Brightness screen display and memory
- Touch to adjust brightness
- Touch screen magnification display and multifunctional

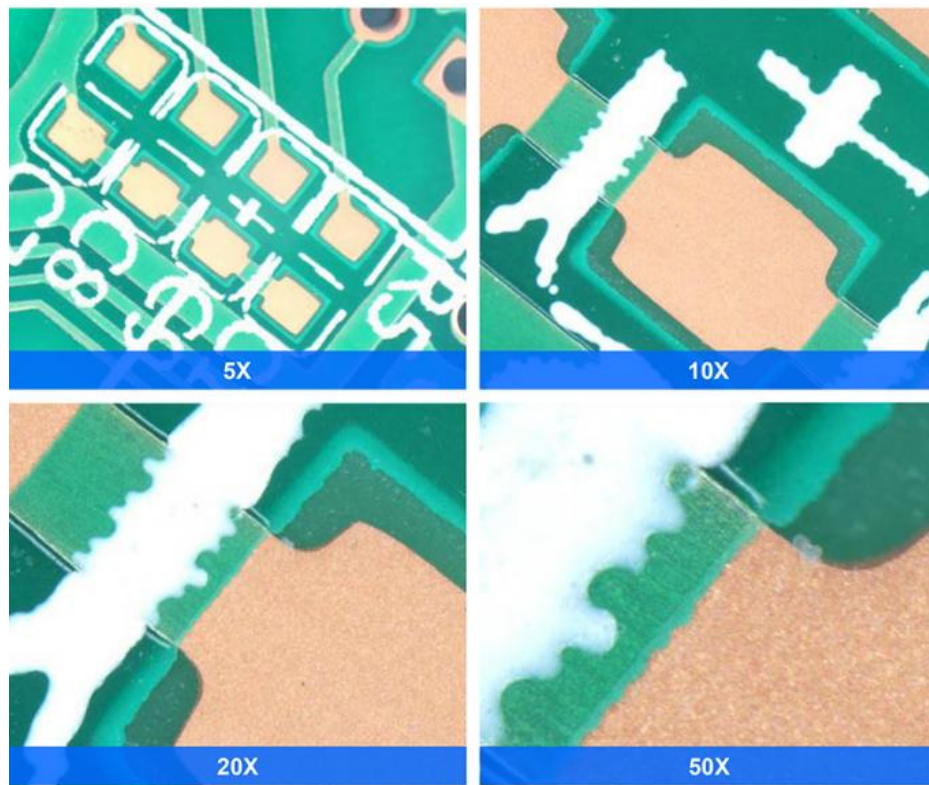

Front Microscope Operation Screen, Achieving Full Electric Control

A13.1098 adds a microscope operation screen at the front end of the microscope, which can achieve almost all microscope operations, including electric focusing, platform movement, objective selection, intermediate magnification conversion, side port output selection, aperture adjustment, multifunctional turntable conversion, etc. The control handle is integrated on the right side of the body, greatly reducing desktop space.

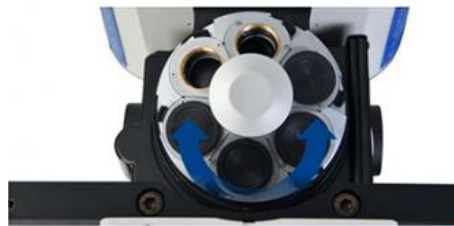
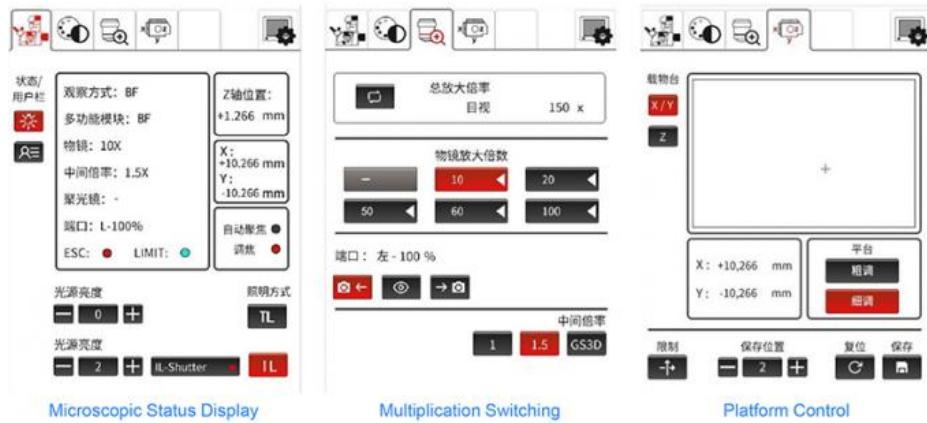

Electric Objective Lens Converter



XY Axis Electric Loading Platform



Z Axis Focusing



Joystick

A13.1096, A13.1097, A13.1098 Applications



With the continuous deepening of material science research, a single observation mode can no longer meet the increasingly complex scientific research and inspection needs. A13.1096,A13.1097,A13.1098 Series can achieve a variety of observation needs, whether basic bright field, polarized light, or complex DIC and silver observation. , Can get clear, true and complete images

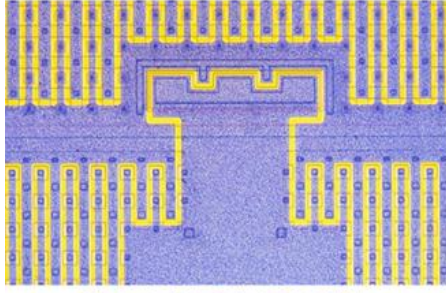

Electronic Chip, Reflect, Bright Field

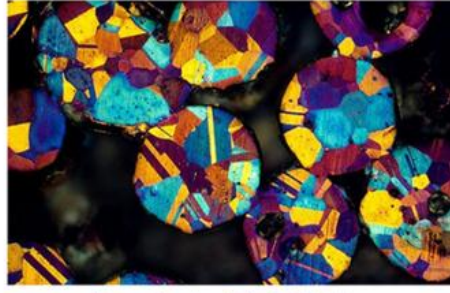

Bronze Powder, Reflect, Polarizing

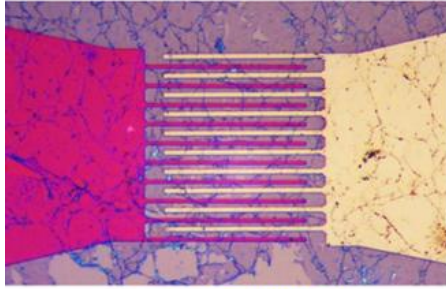

Electrode, Reflect, Bright Field



High Chromium Nickel Alloy, Reflect, Polarizing

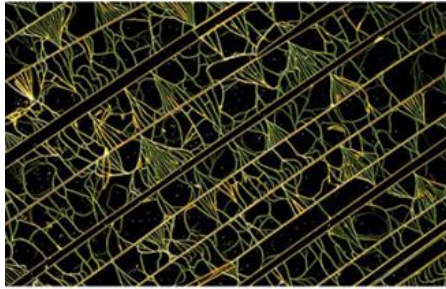

Embossing Of Silicon Nitride, Reflect, Dark Field

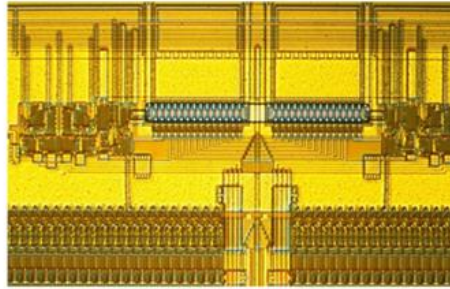

Integrated Circuit, Reflect, DIC

BF	DF	DIC	PL
----	----	-----	----

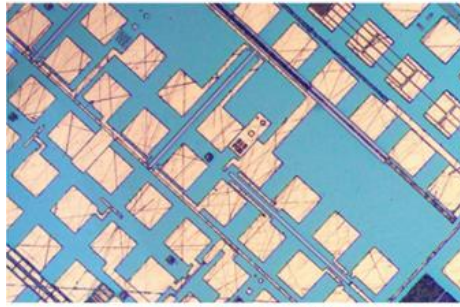

Electronic Chip, Reflection, Bright Field

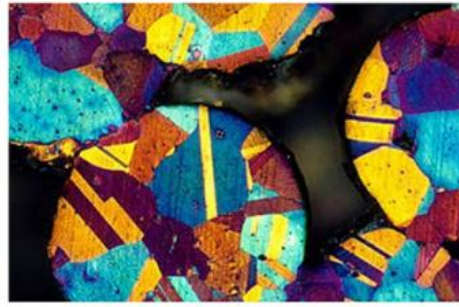

Bronze Powder, Reflective, Polarized

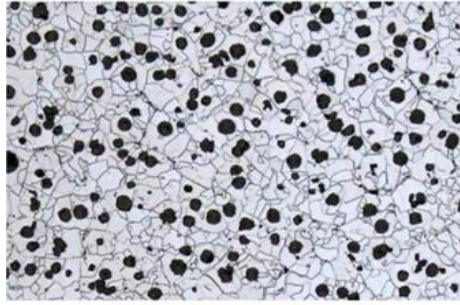

Carbon Steel, Reflective, Bright Field

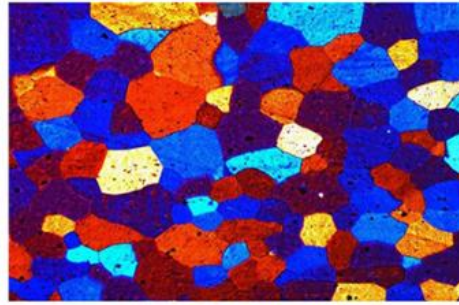

Alloy, Reflection, Polarization

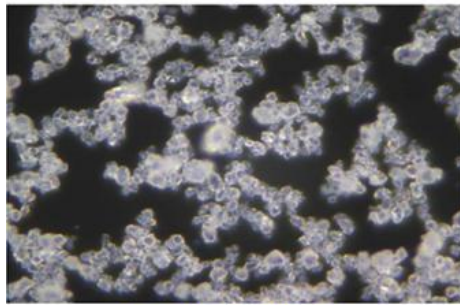

Crystal, Reflection, Dark Field

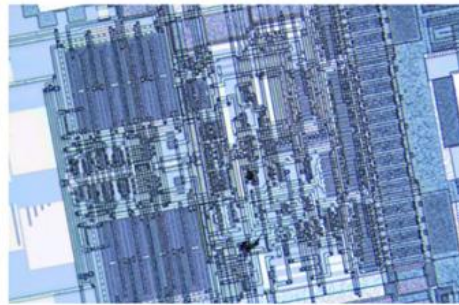

Integrated Circuit, Reflection, DIC



A59.2225

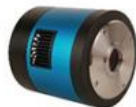

A59.2226



With high speed USB3.0 digital camera and professional image processing software, Opto-Edu microscope can work with computer to get various advanced function done easily. Real Time / Static Measure, 2D Image Scan & Stitching, 3D Depth of Field Fusion, Fluorescent Image Synthesis, Cell Counting and etc.

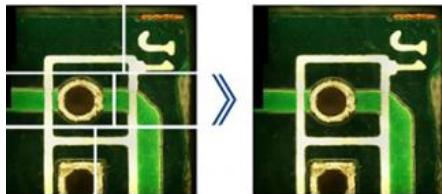

◆ 2D Image Scan & Stitching

Imaging software for high-quality image acquisition, processing and analysis. By collecting images in real time or importing images, small images can be spliced quickly to form a large-size, high-resolution image.

◆ Real-time / static measurement

Typical observation and quality control require interactive measurement functions such as distance, angle, rectangle, circle and ellipse.

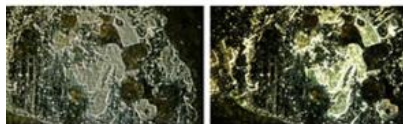

◆ High-definition real-time HDR image/video

When observing different samples, the surface of the sample will show areas of high contrast. HDR allows users to complete the generation of perfect exposure images between clicks

◆ 3D Depth Of Field Fusion

Provides depth fusion and 3D reconstruction functions





A13.1096

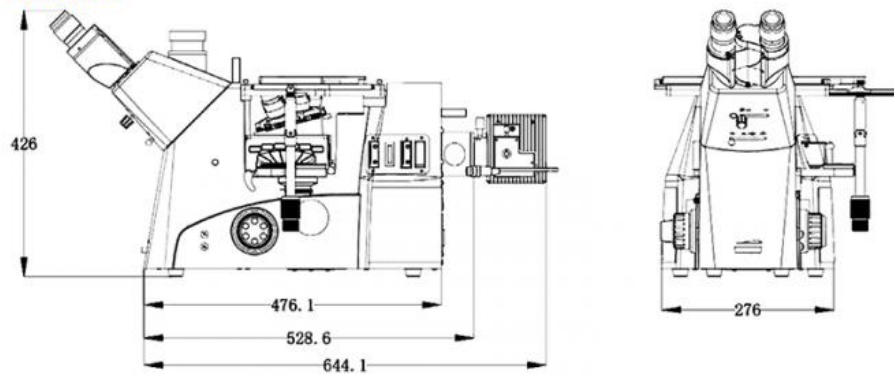

A13.1097

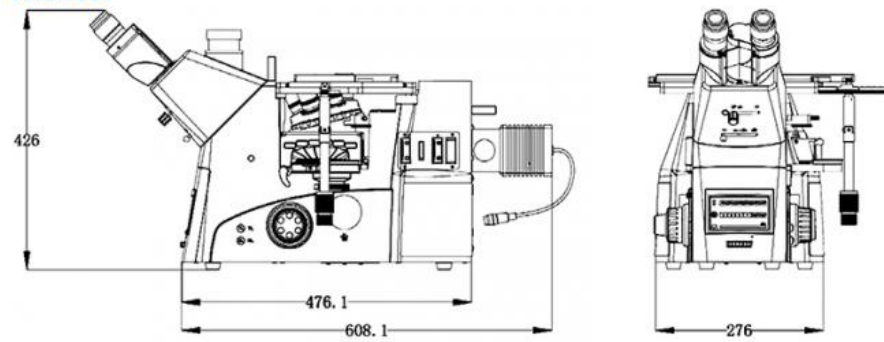

A13.1098

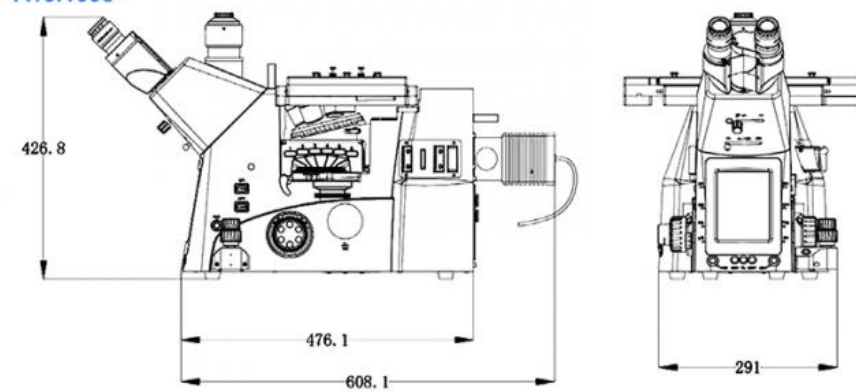

A13.1096, A13.1097, A13.1098 Structure

OPTO-EDU

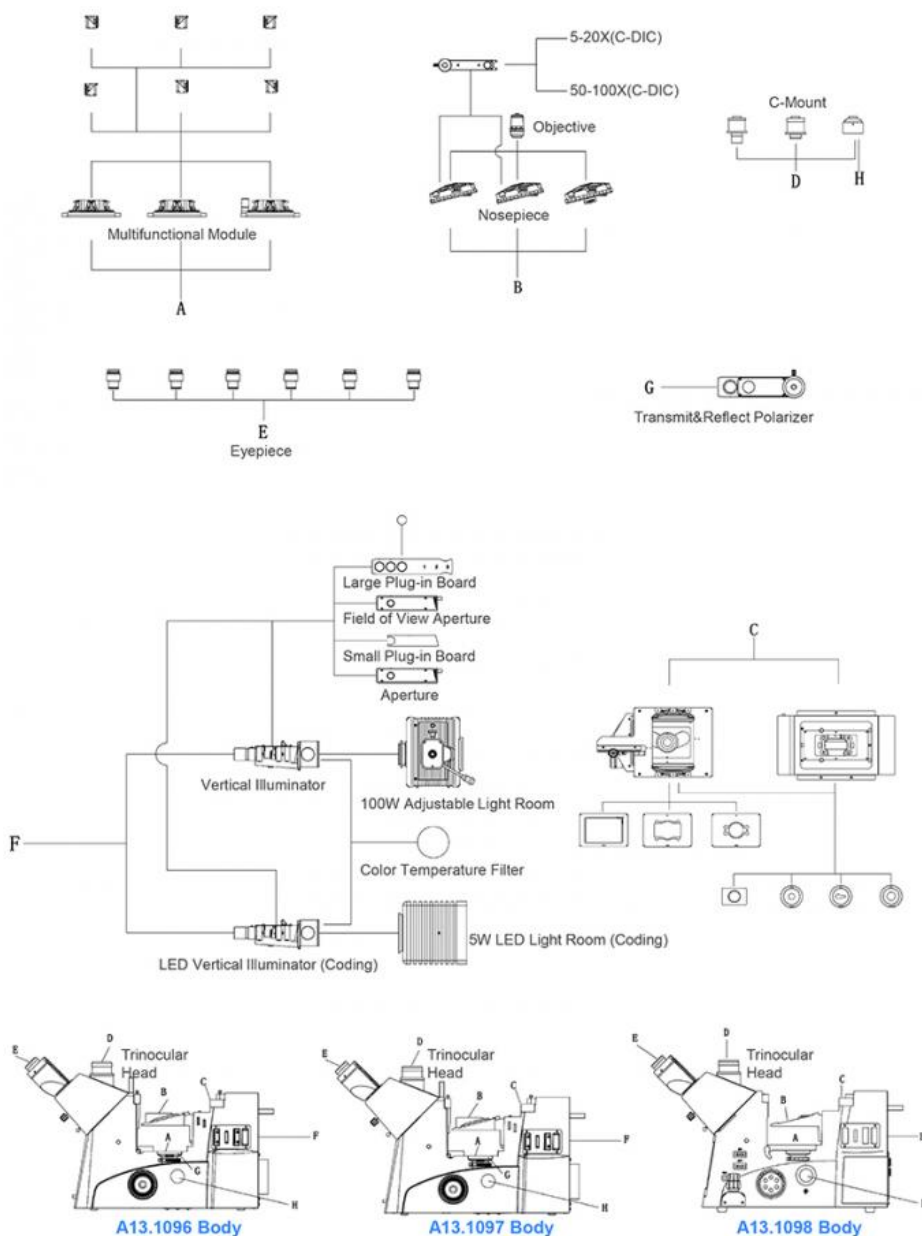

A13.1096, A13.1097, A13.1098 Specification

OPTO-EDU



A13.1096, A13.1097, A13.1098		A13.1096	A13.1097	A13.1098	Cata. No.
Research Level Inverted Metallurgical Microscope		6 Manual	7 Coded	8 Auto	
Optical System	NIS60 Infinite Optical System	●	●	●	
Observation Method	Bright Field	●	●	●	
	Dark Field	○	○	○	
	Polarizing	○	○	○	
	DIC	○	○	○	
Head	Seidentopf Trinocular Head, Inclined 45°, Interpupillary Distance 47-78mm, Ligth Split Switch E100:P0/E20:P80/E0:P100, With Built-in Bertrand Lens Which Can Be Used As Centering Telescope	●	●	●	
Eyepiece (Dia.30mm)	SW10x/25mm, High Eyepoint, Diopter Adjustable	○	○	○	A51.1090-1025
	SW10x/22mm, High Eyepoint, Diopter Adjustable	●	●	●	A51.1090-1022
	EW12.5x/17.5mm, High Eyepoint, Diopter Adjustable	○	○	○	A51.1090-12516
	WF15x/16mm, High Eyepoint, Diopter Adjustable	○	○	○	A51.1090-1516

	WF20x/12mm, High Eyepoint, Diopter Adjustable	○	○	○	A51.1090-2012
Media Lens	Built-in Media Lens Turret, Under Nosepiece, 1.0x, 1.5x Switchable	●	●	●	
Nosepiece	Manual Sextuple Nosepiece, With DIC Slot	●			
	Coded Manual Sextuple Nosepiece, With DIC Slot		●		
	Motorized Sextuple Nosepiece, With DIC Slot			●	
NIS45 Infinity Plan BF/DF Semi-APO/ APO Metallurgical Objective	5x/0.15, W.D.20mm, No Cover Glass, Semi-APO	●	●	●	A5M.1091-5
	10x/0.3, W.D.11mm, No Cover Glass, Semi-APO	●	●	●	A5M.1091-10
	20x/0.45, W.D.3mm, No Cover Glass, Semi-APO	●	●	●	A5M.1091-20
	50x/0.8, W.D.1mm, No Cover Glass, APO	●	●	●	A5M.1092-50
Working Stage	100x/0.9, W.D.1mm, No Cover Glass, APO	●	●	●	A5M.1092-100
	Three Layer Mechanical Stage, Size 340x230mm, Moving Range 130x85mm, Flexible Knob, Available For Different Size Small Stage Plate, Can Hold Max Weight 30Kgs	●	●	○	A54.1098
	Motorized X/Y Axis (Optical Grating Type) Mechanical Stage, Size 325x144mm, Moving Range 130x100mm, Max Speed 10mm/s, Resolution 0.1um, Repeat Accuracy +/-0.5um, Available For Different Size Small Stage Mounted on Top Layer, With Separate Communication/Main Control Box & Stick	○	○	●	A54.1098-M
	Metal Plate Dia.20mm	●	●	●	A54.1098-M20
	Metal Plate Dia.28mm	●	●	●	A54.1098-M28
Focusing	Metal Plate Water Drop Shape	●	●	●	A54.1098-MW
	Manual Coaxial Coarse & Fine Focusing, Focusing Range 9mm (Up 2mm, Down 7mm), Coarse Stroke 2mm, Fine Stroke 0.2mm	●	●		
	Motorized Z Axis (Optical Grating Type) Focusing System, Focusing Range 9mm (Up 7mm, Down 2mm), Focusing Resolution 0.02um With Optical Grating, Movement Repeat Positioning Accuracy +/-0.1um, Prevent Stage Fall Down Function				●
	3 Camera Ports, On Both Side Of Main Body And Head, Turret Switch Between: --Trinocular Port Switch E100:P0/E20:P80/E0:P100 --Left Port C-Mount 1.0x E0:P100 --Right Port C-Mount 1.0x E20:P80	●	●	●	
Adapter	C-Mount 0.4x	○	○	○	A55.1095-04
	C-Mount 0.5x	○	○	○	A55.1095-05
	C-Mount 1.0x	●	●	●	A55.1095-10
Multi Function Turret	Manual Multi Function Turret Under Nosepiece, With 6 Positions For Cubes Of Bright Field, Dark Field, Phase Contrast, Polarizing, Fluorescent View, Turning The Disc To Easily Switch Observation Methods	●			
	Coded Multi Function Turret Under Nosepiece, With 6 Positions For Cubes Of Bright Field, Dark Field, Phase Contrast, Polarizing, Fluorescent View, Turning The Disc To Easily Switch Observation Methods		●		
	Motorized Multi Function Turret Under Nosepiece, With 6 Positions For Cubes Of Bright Field, Dark Field, Phase Contrast, Polarizing, Fluorescent View, Turning The Disc To Easily Switch Observation Methods			●	
Bright Field	Bright Field Block, Put In Multi Function Turret	●	●	●	
Dark Field	Dark Field Block, Put In Multi Function Turret	●	●	●	A5D.1098
Polarizing	Polarizer + λ Light Block, Put In Multi Function Turret	●	●	●	A5P.1098-PLA
	Polarizer Light Block, Put In Multi Function Turret	○	○	○	A5P.1098-PL
	Circularly Polarized Light Block, Put In Multi Function Turret	○	○	○	A5P.1098-CP
	Analyzer Slide, Insert Into Slot On Nosepiece, 360° Rotatable	●	●	●	A5P.1098-A
DIC	DIC Slider 5x-20x, Insert Into Slot On Nosepiece	○	○	○	A5C.1097-S520
	DIC Slider 50x-100x, Insert Into Slot On Nosepiece	○	○	○	A5C.1097-S50100
Reflect Light Soruce	12V100W Halogen Kohler Illumination, Brightness Adjustable	●			A56.1095-12V100W
	5W LED, Brightness Adjustable		●	●	
	Large Filter Holder Slide With 3 Holes	●	●	●	A56.1095-LS
	Field Diaphragm Slide, Center Adjustable,	●	●	●	A56.1095-FS
	Small Empty Slide	●	●	●	A56.1095-ES
	Aperture Diaphragm Slide	●	●	●	A56.1095-AS
	ND6 Filter	○	○	○	A56.1095-ND6
ND25 Filter	○	○	○	A56.1095-ND25	
Software	NOMIS Basic Image Processing Software	○	○	○	A30.1090

Note: "●" In Table Is Standard Outfits, "○" Is Optional Accessories "-" Is Unavailable



Opto-Edu (Beijing) Co., Ltd.

 0086 13911110627

 sale@optoedu.com

 cnoec.com

F-1501 Wanda Plaza, No. 18 Shijingshan Road, Beijing 100043, China